

4 Person Double Elimination

Land: _____ Date: _____

Warmaster/Weaponmaster/ _____

Event: _____

Winner's Bracket

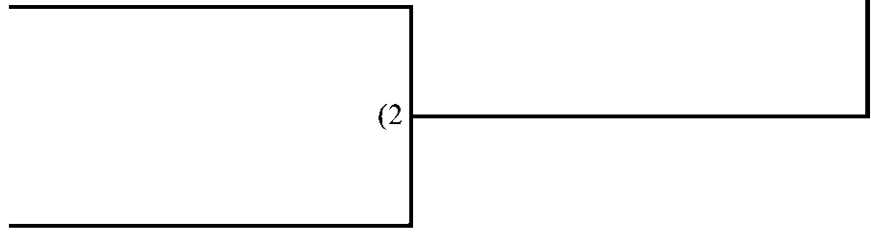
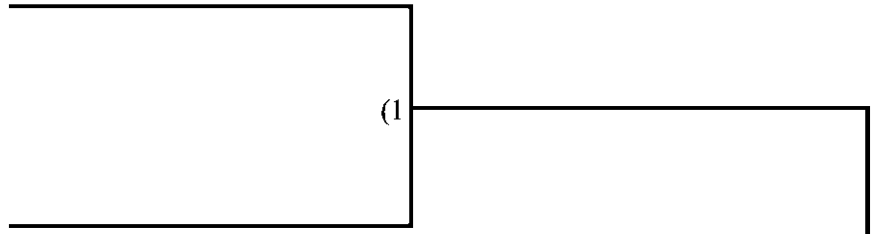

Loser's Bracket

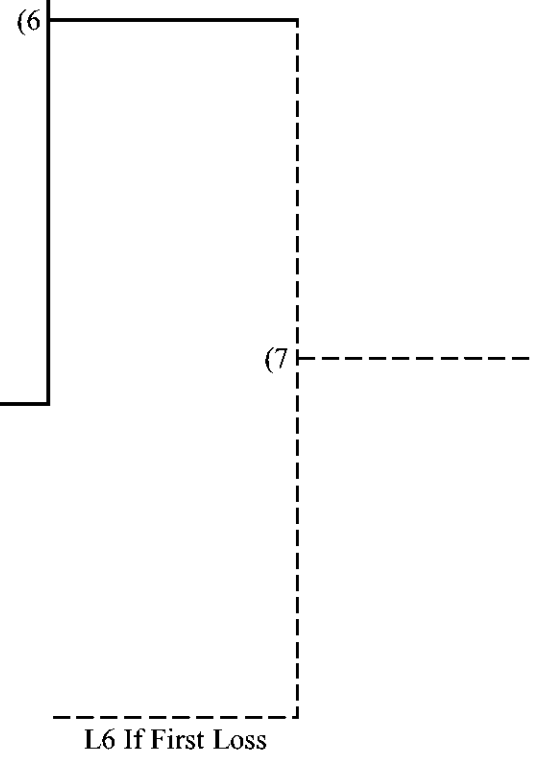
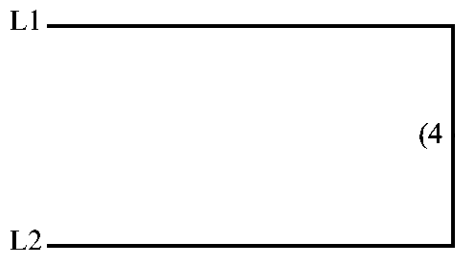
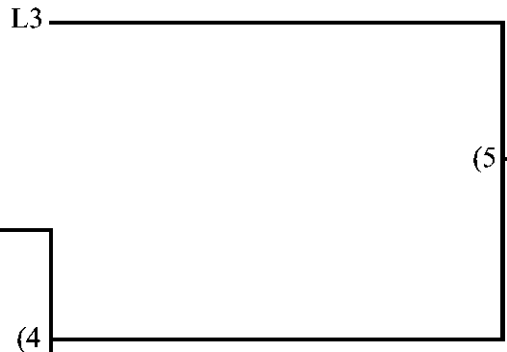

5 Person Double Elimination

Land: _____ Date: _____

Warmaster/Weaponmaster/ _____

Event: _____

Winner's Bracket

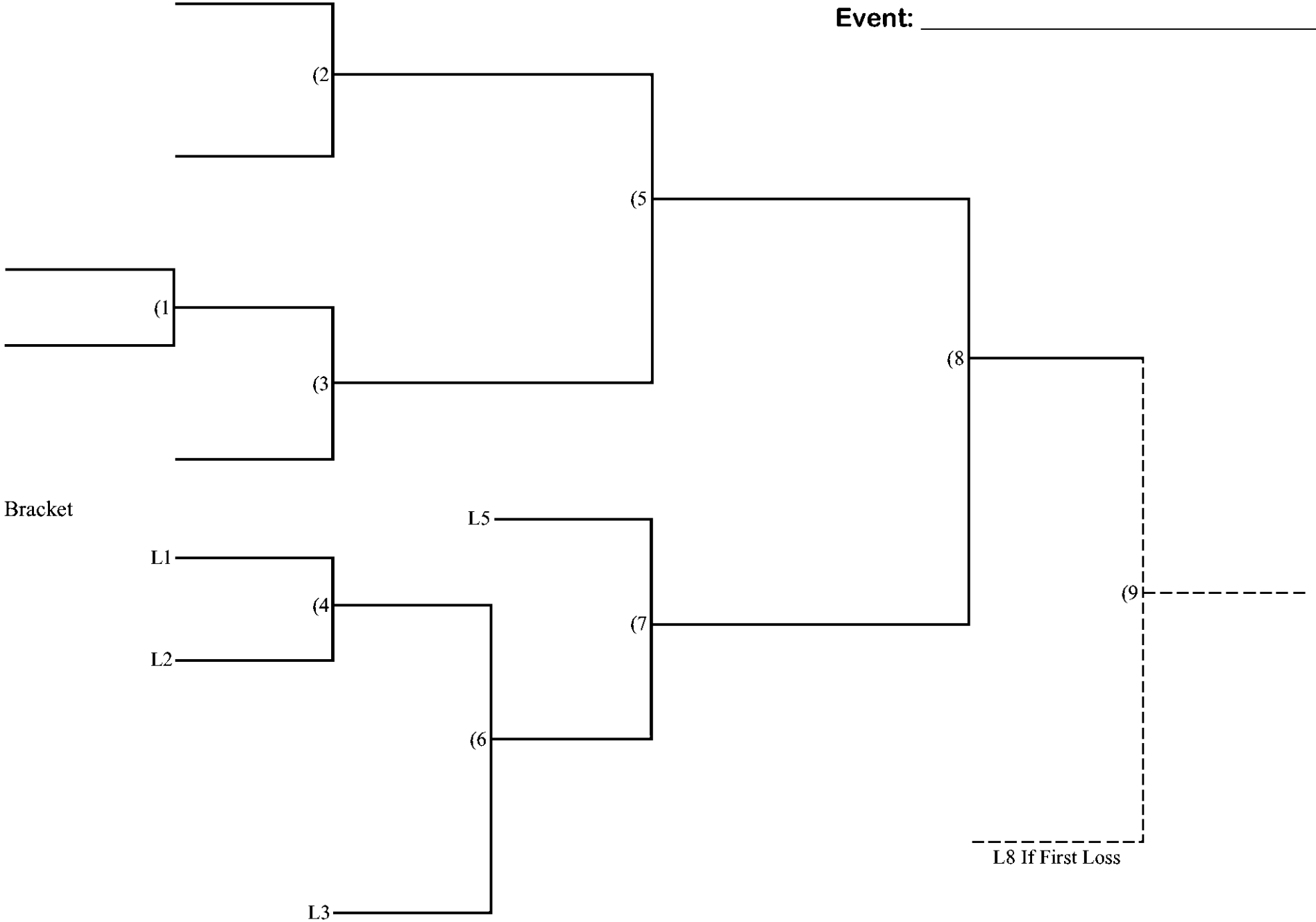

Loser's Bracket

L8 If First Loss

6 Person Double Elimination

Land: _____ Date: _____

Warmaster/Weaponmaster/ _____

Event: _____

Winner's Bracket

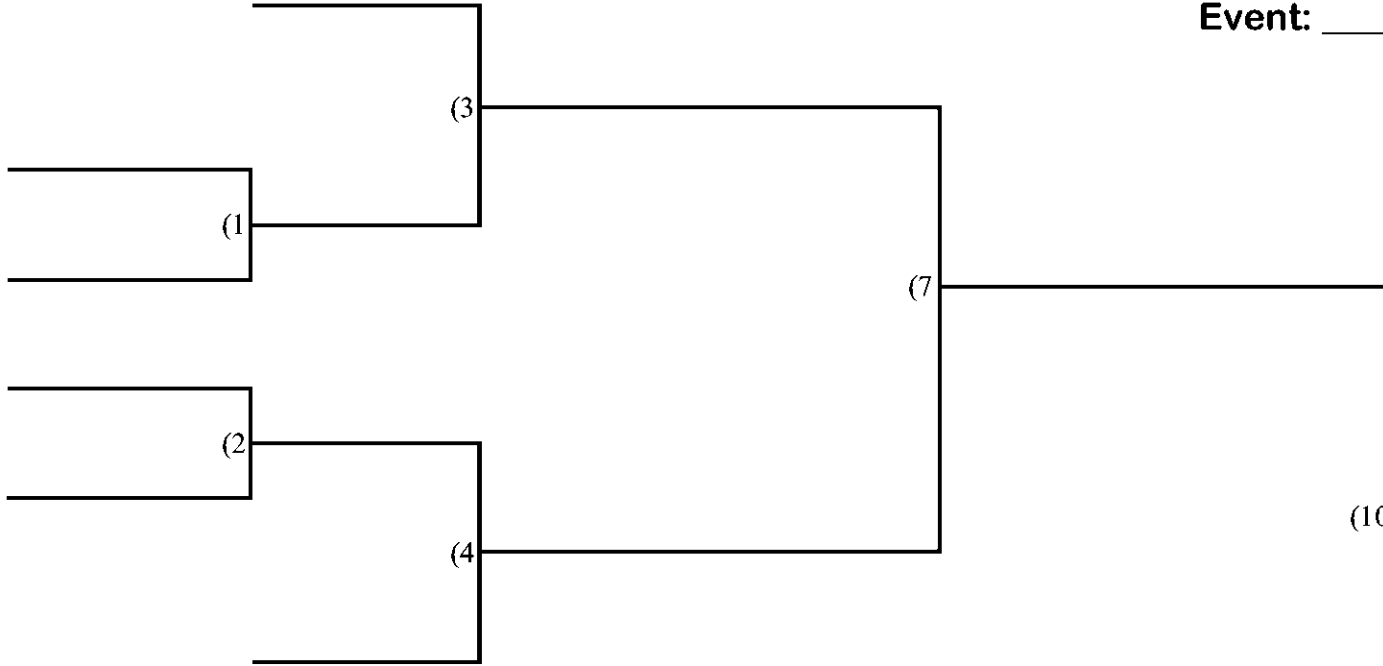

Loser's Bracket

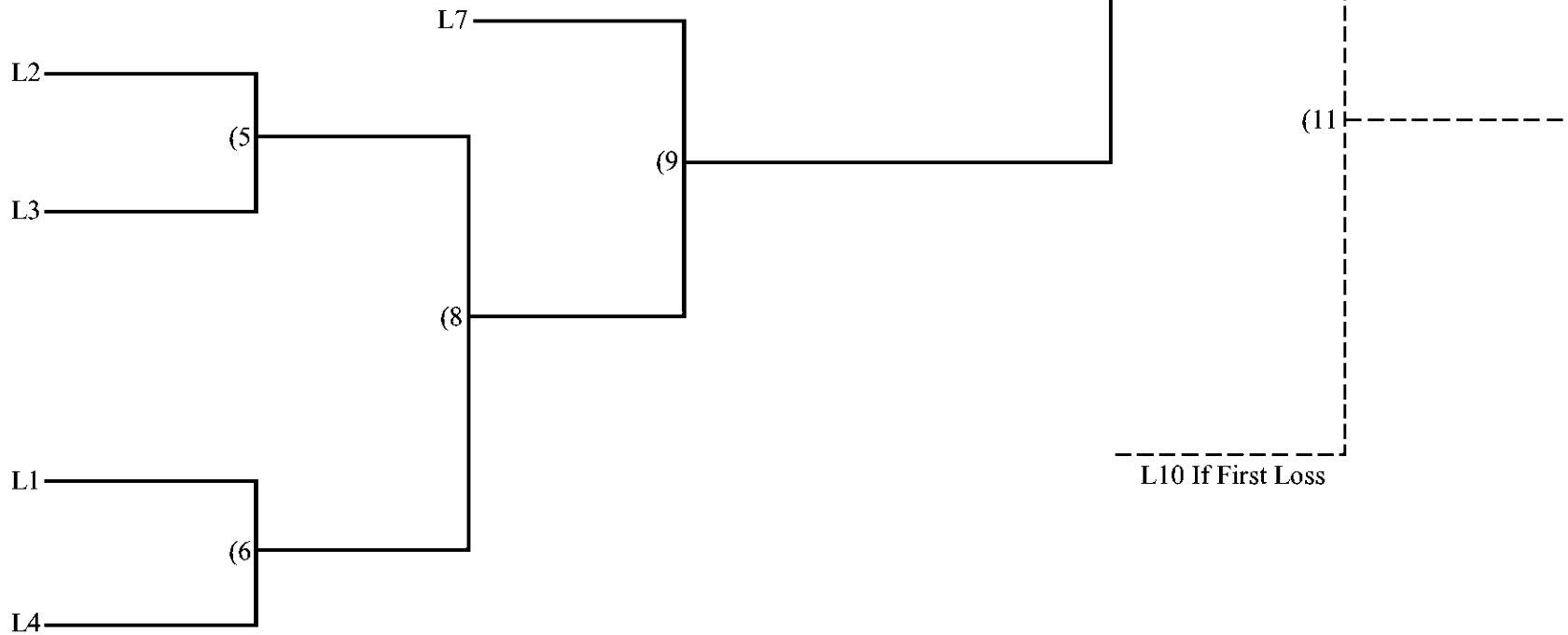

7 Person Double Elimination

Land: _____ Date: _____

Warmaster/Weaponmaster/ _____

Event: _____

Winner's Bracket

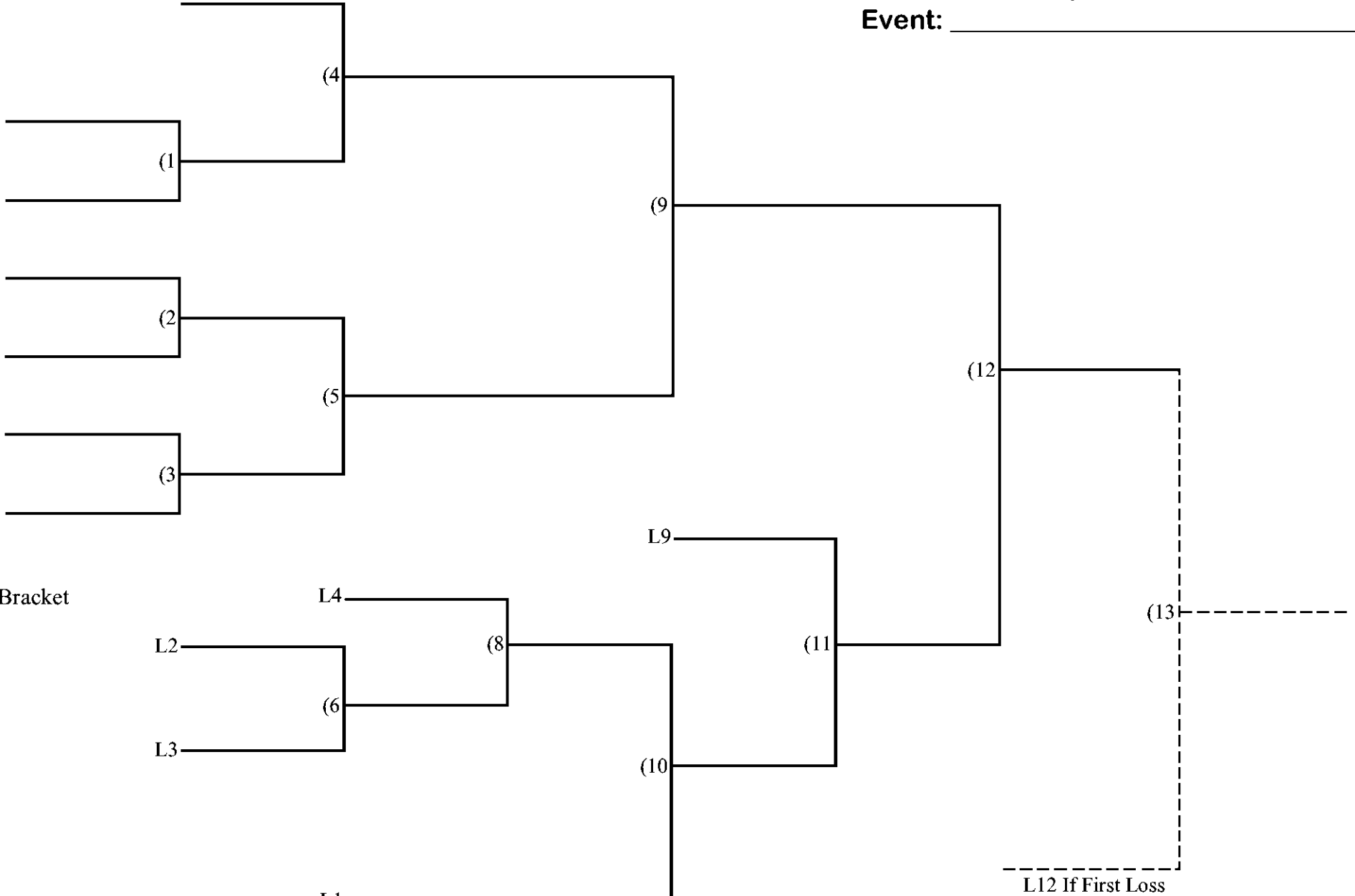

Loser's Bracket

L12 If First Loss

Winner's Bracket

8 Person Double Elimination

Land: _____ Date: _____
Warmaster/Weaponmaster/ _____
Event: _____

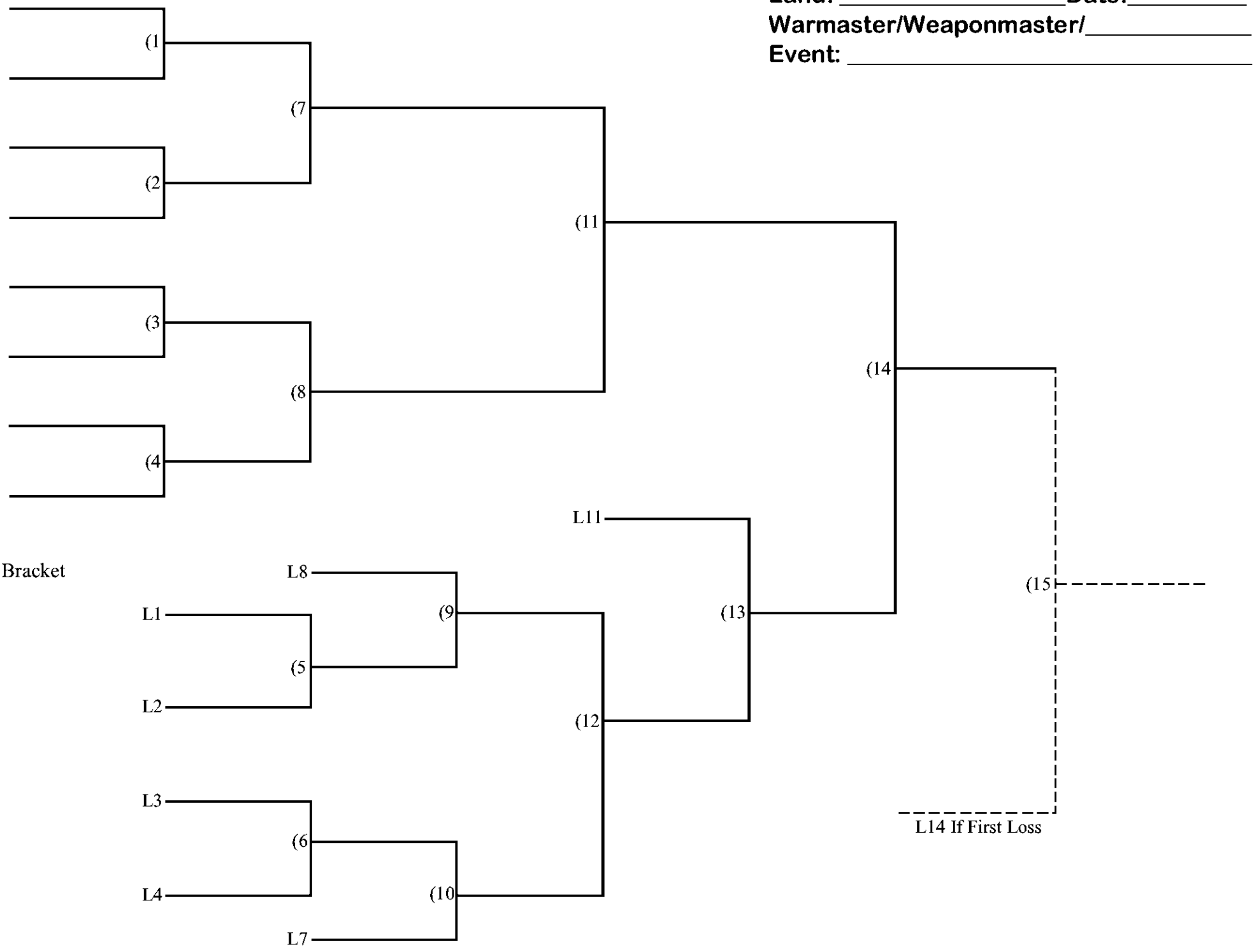

Winner's Bracket

9 Person Double Elimination

Land: _____ Date: _____
Warmaster/Weaponmaster/ _____
Event: _____

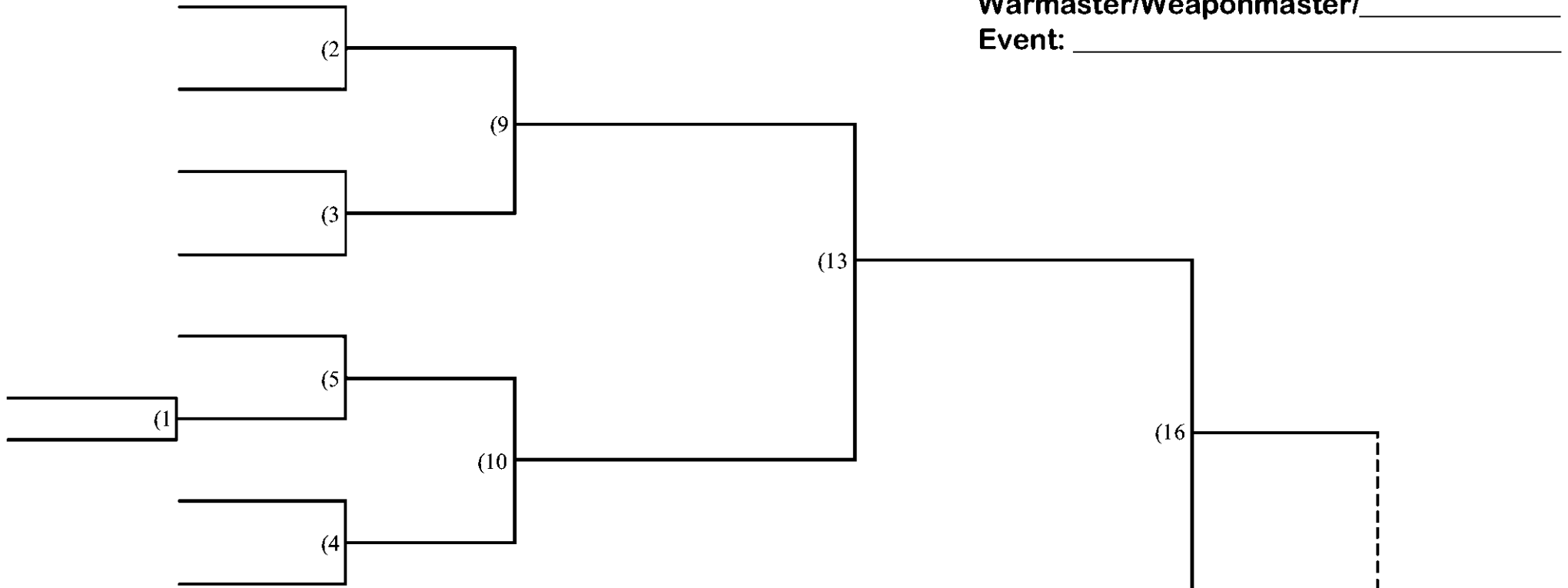

Loser's Bracket

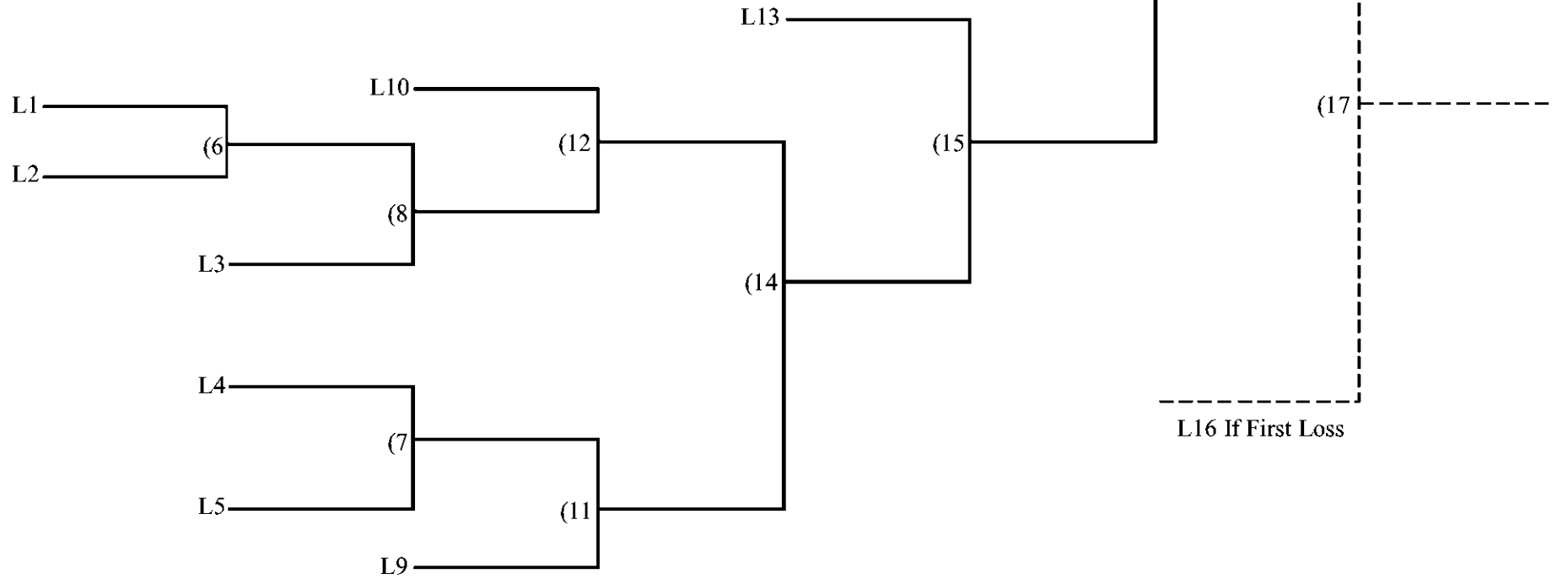

10 Person Double Elimination

Land: _____ Date: _____

Warmaster/Weaponmaster/ _____

Event: _____

Winner's Bracket

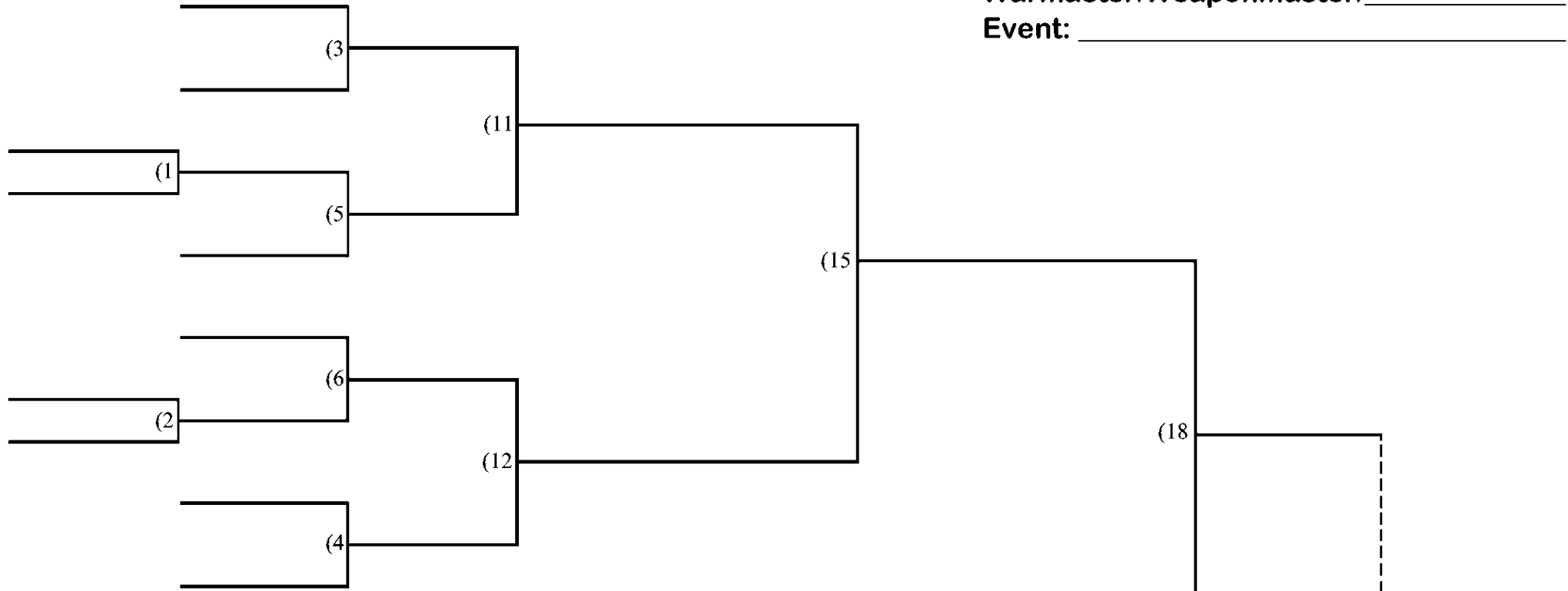

Loser's Bracket

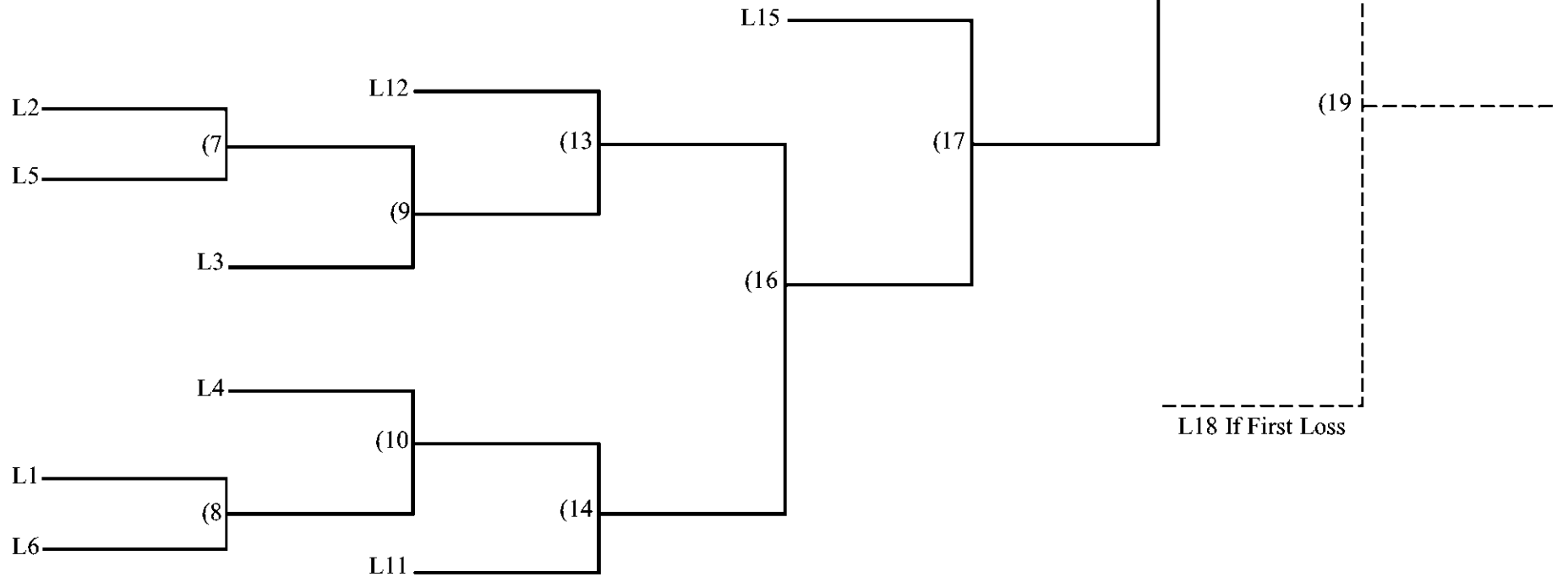

11 Person Double Elimination

Land: _____ Date: _____

Warmaster/Weaponmaster/ _____

Event: _____

Winner's Bracket

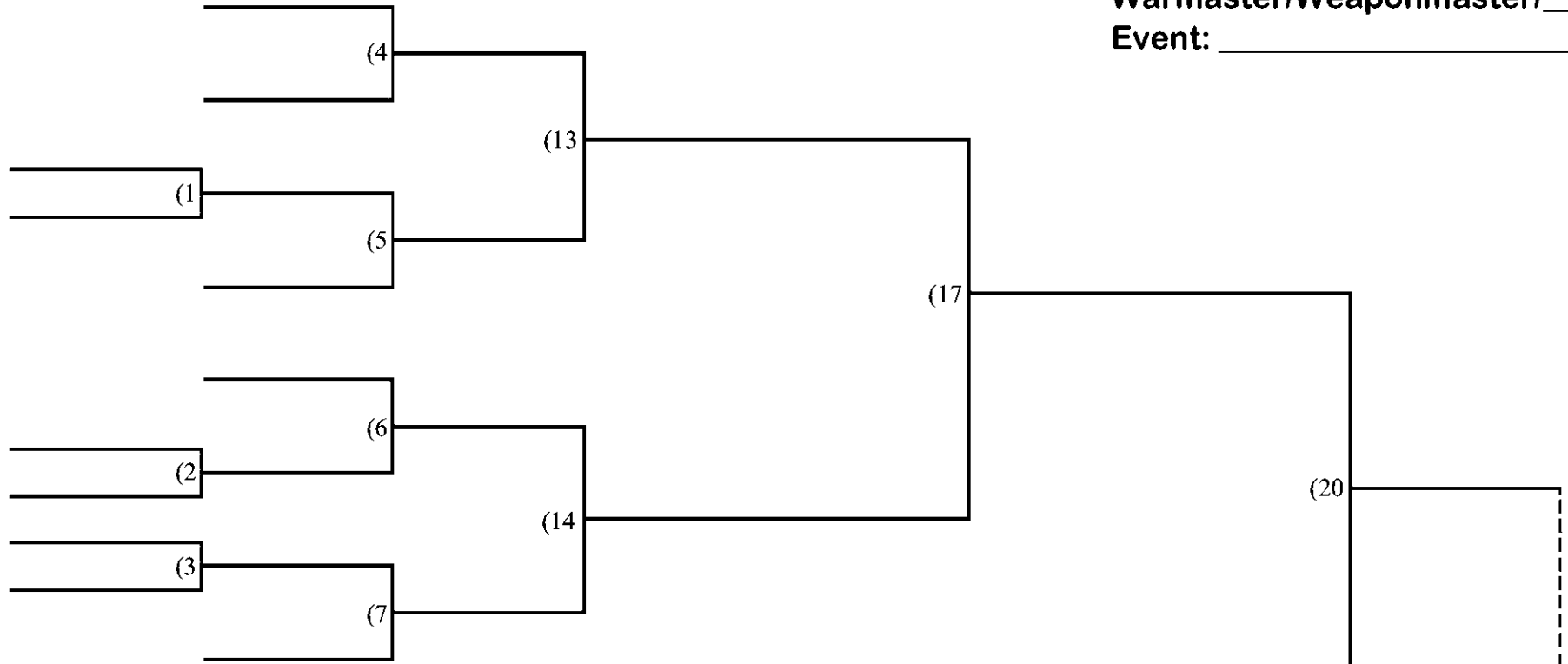

Loser's Bracket

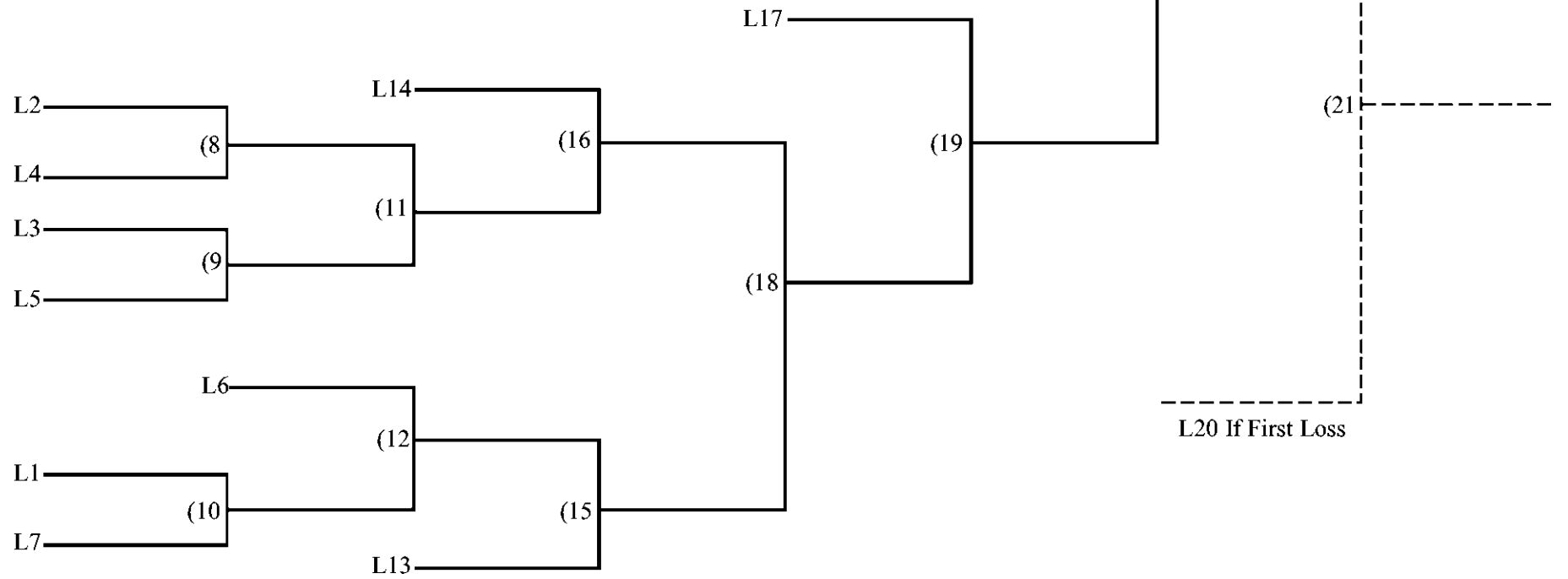

L20 If First Loss

25 Person Double Elimination

Land: _____ Date: _____

Warmaster/Weaponmaster/ _____

Event: _____

Winner's Bracket

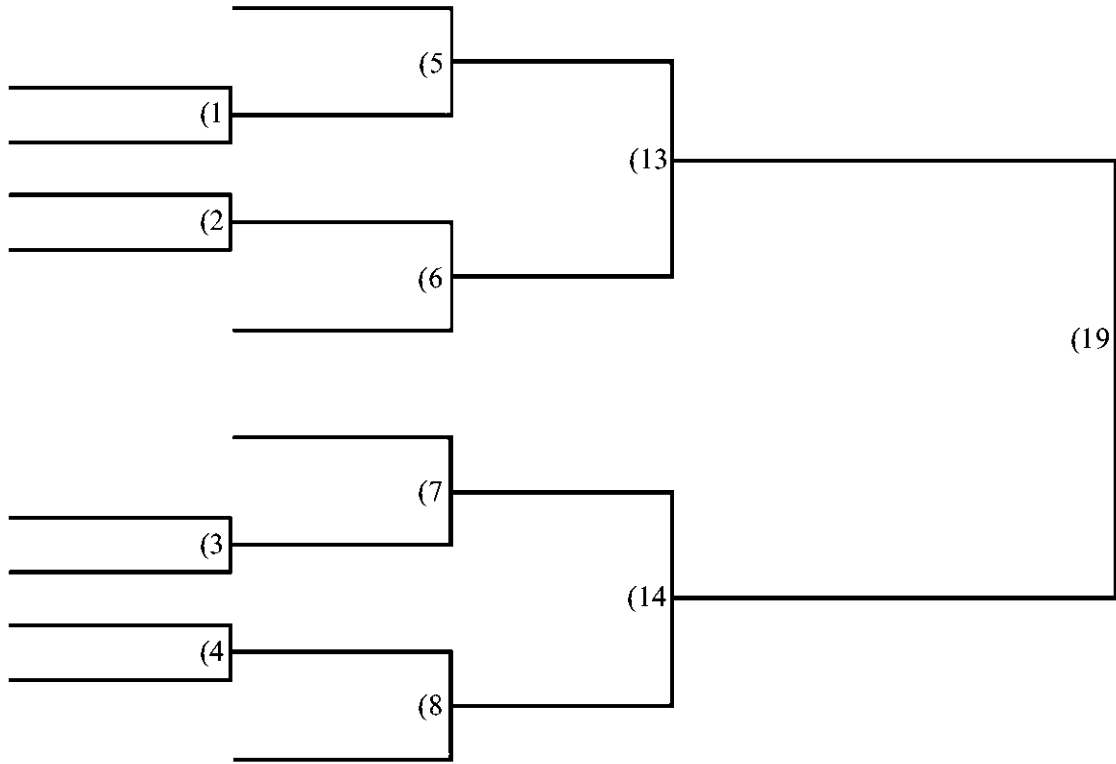

Loser's Bracket

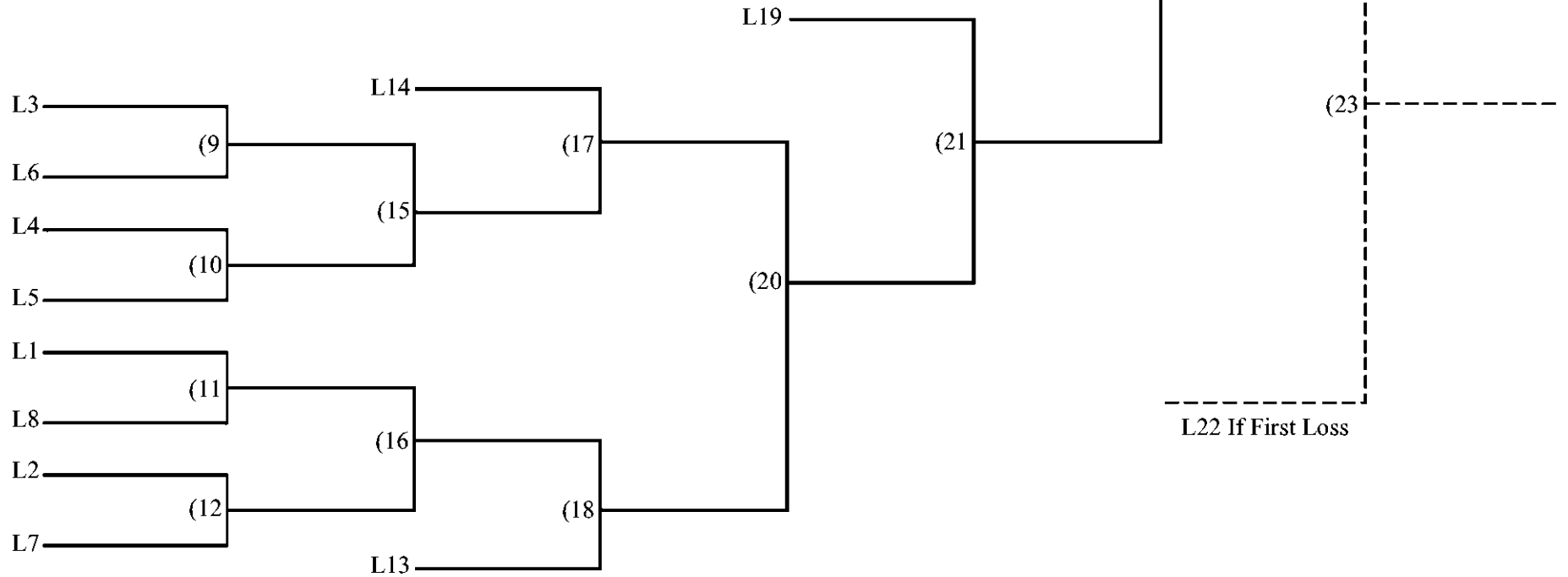

Winner's Bracket

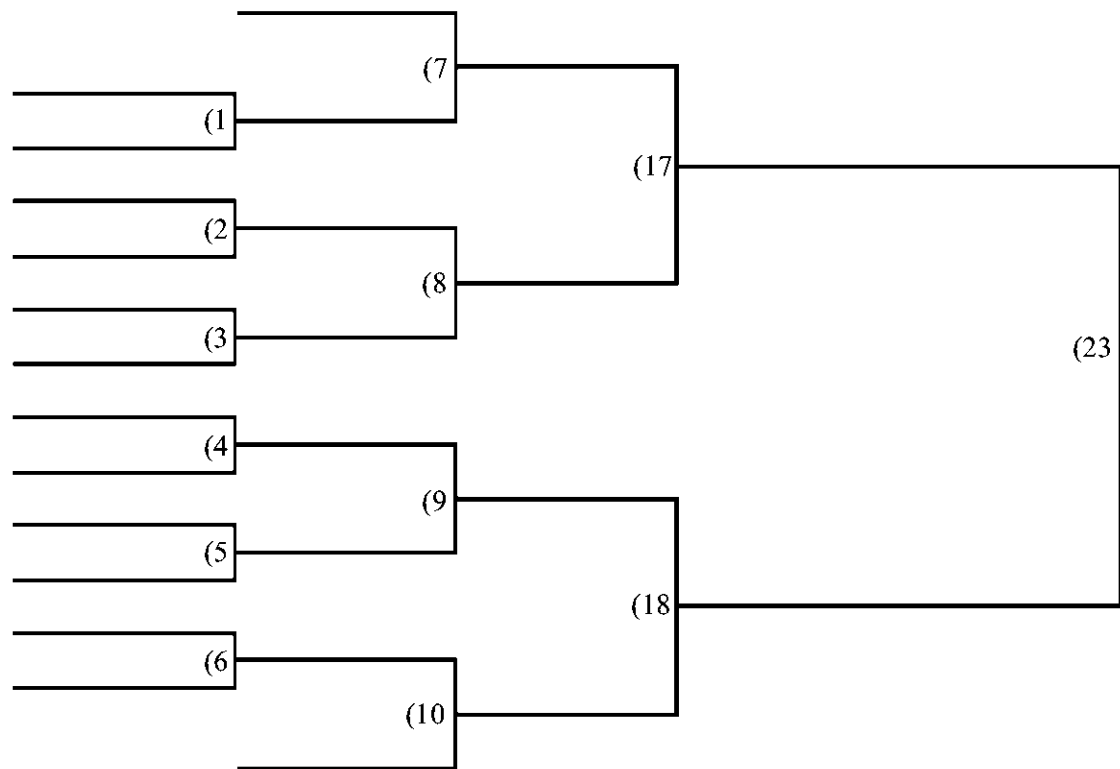

14 Person Double Elimination

Land: _____ Date: _____

Warmaster/Weaponmaster/ _____

Event: _____

Loser's Bracket

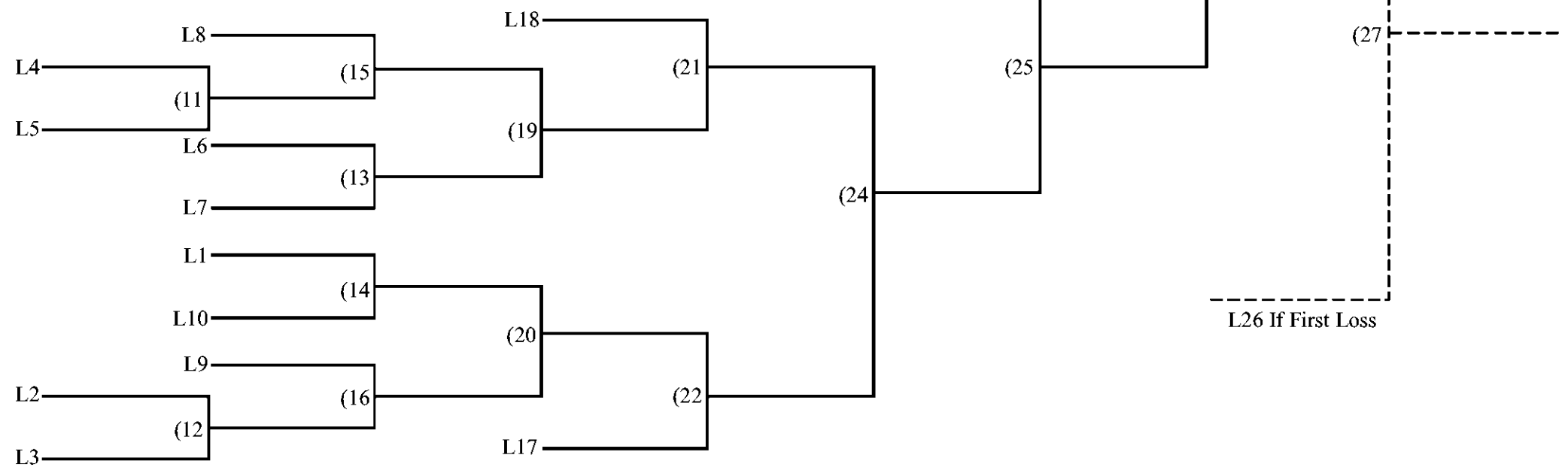

Winner's Bracket

15 Person Double Elimination

Land: _____ Date: _____
Warmaster/Weaponmaster/ _____
Event: _____

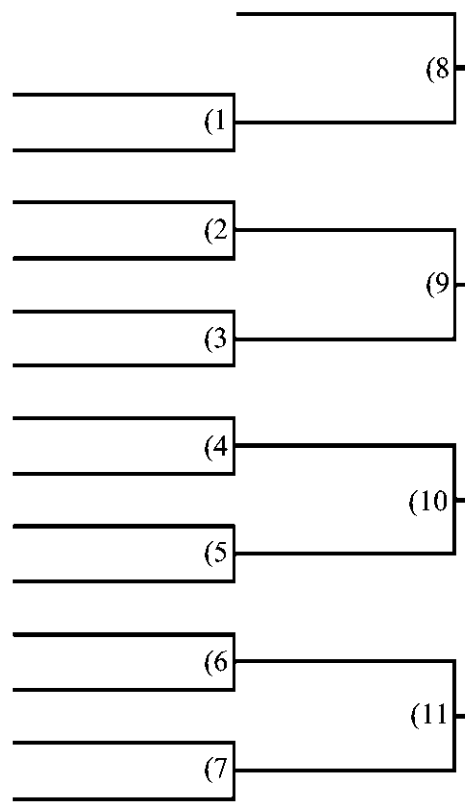

Loser's Bracket

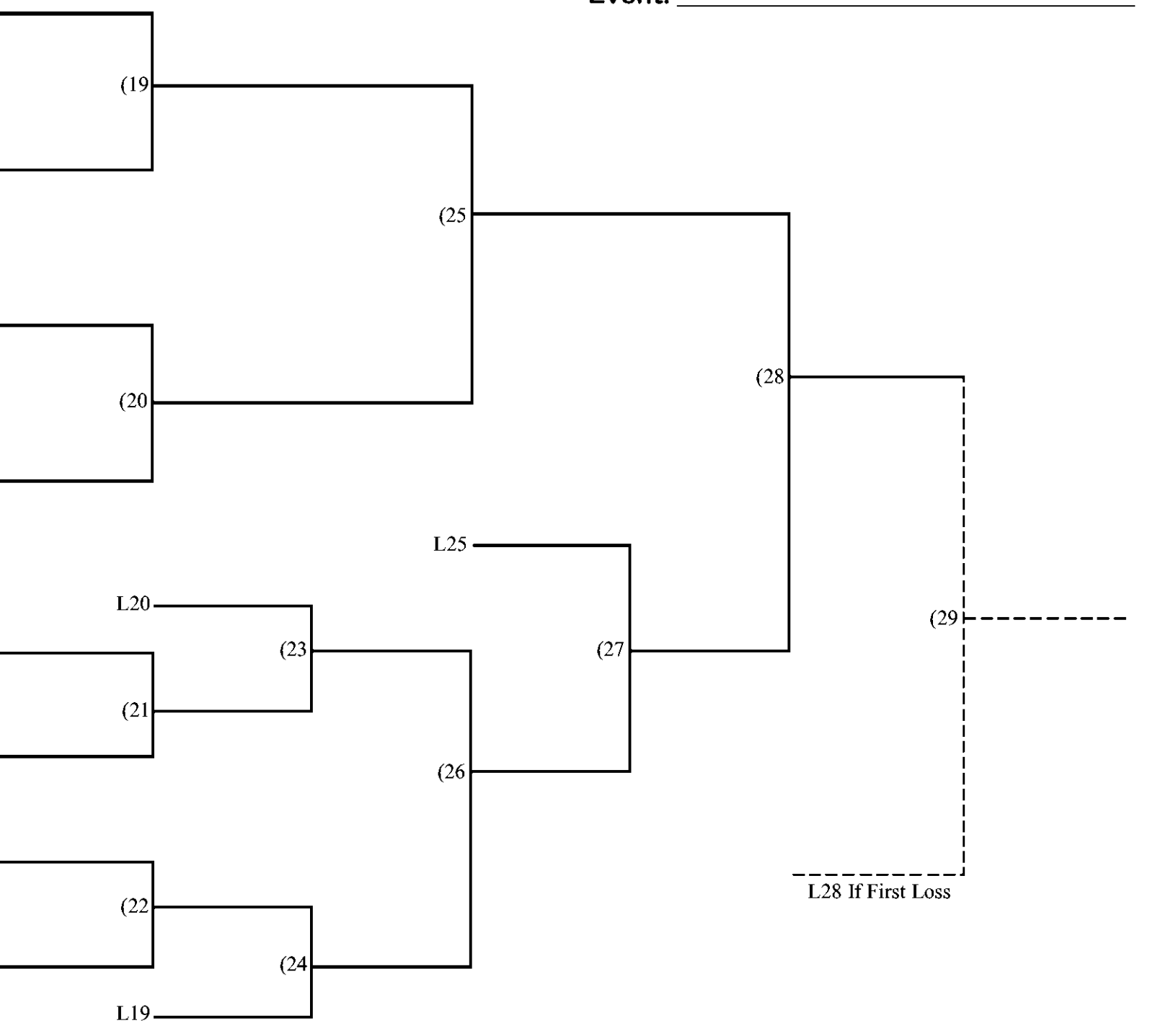
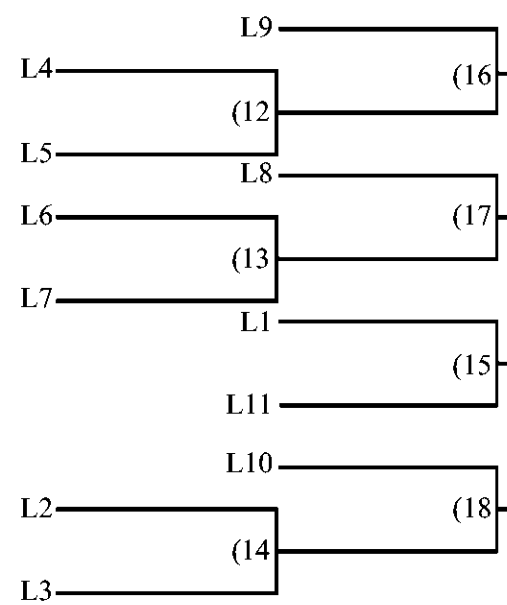

L28 If First Loss

Winner's Bracket

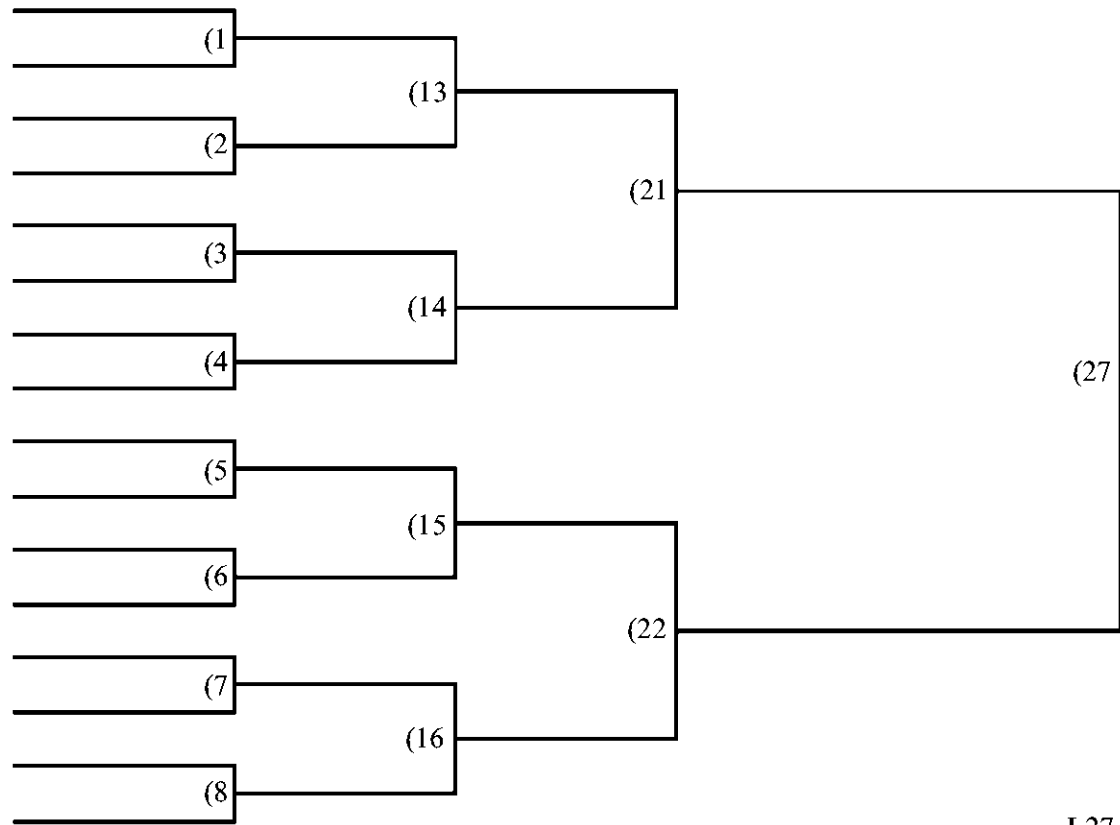

16 Person Double Elimination

Land: _____ Date: _____
 Warmaster/Weaponmaster/ _____
 Event: _____

Loser's Bracket

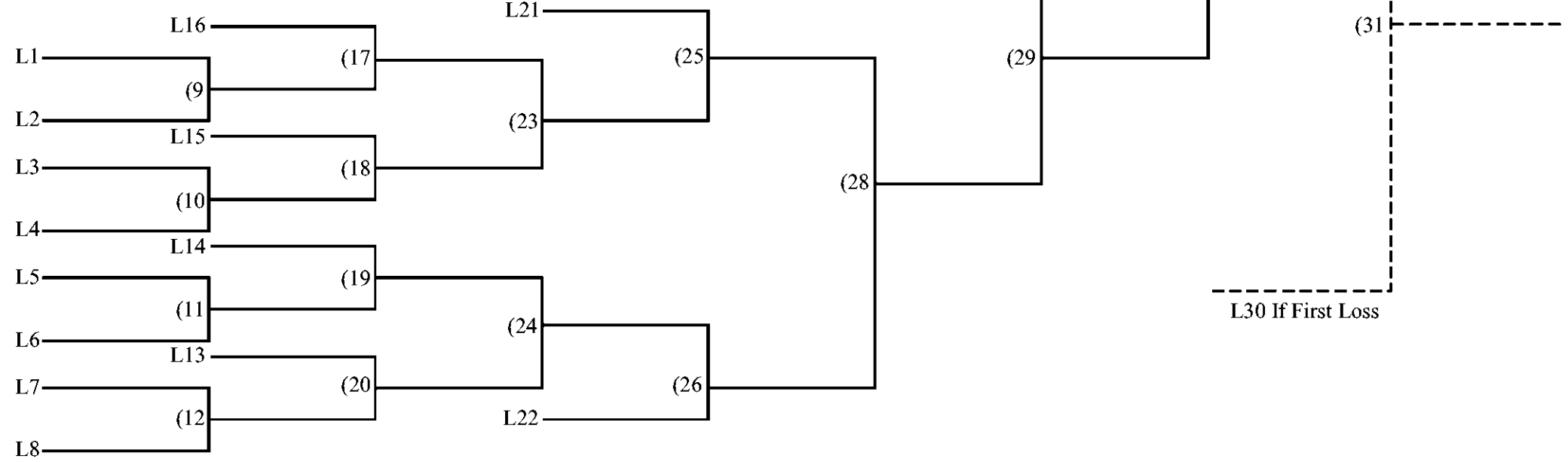

Winner's Bracket

17 Person Double Elimination

Land: _____ Date: _____

Warmaster/Weaponmaster/ _____

Event: _____

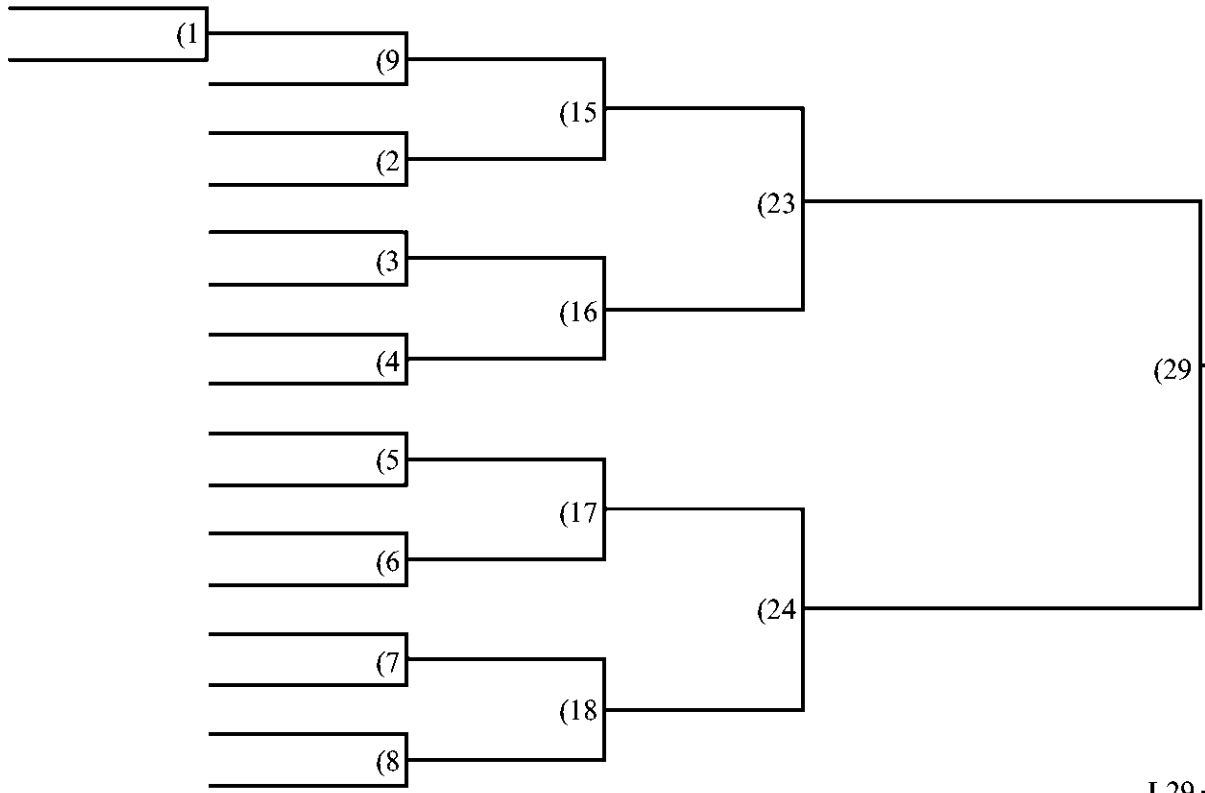

Loser's Bracket

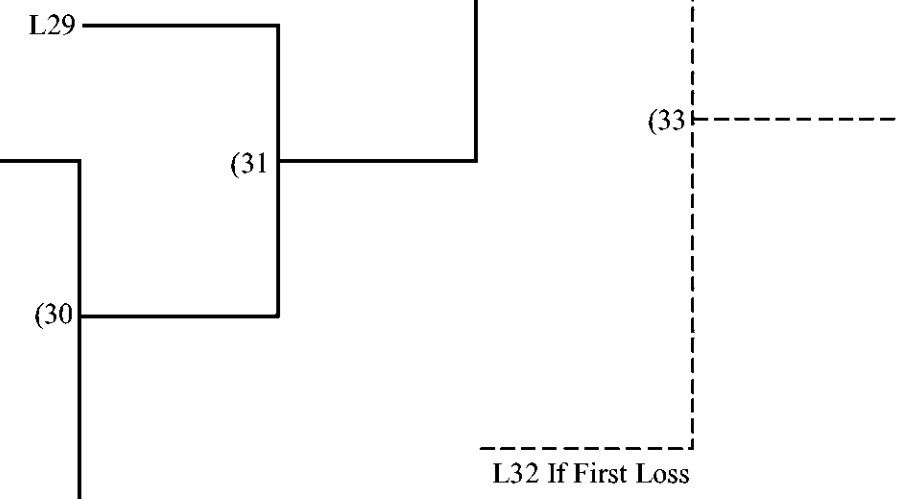
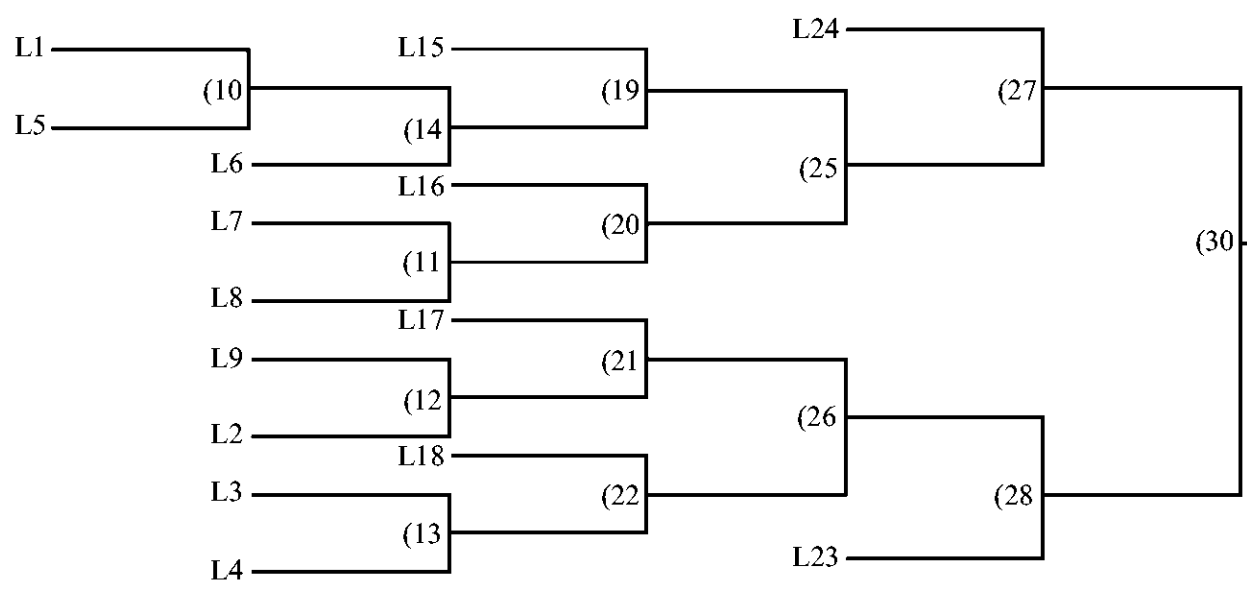

Winner's Bracket

18 Person Double Elimination

Land: _____ Date: _____

Warmaster/Weaponmaster/ _____

Event: _____

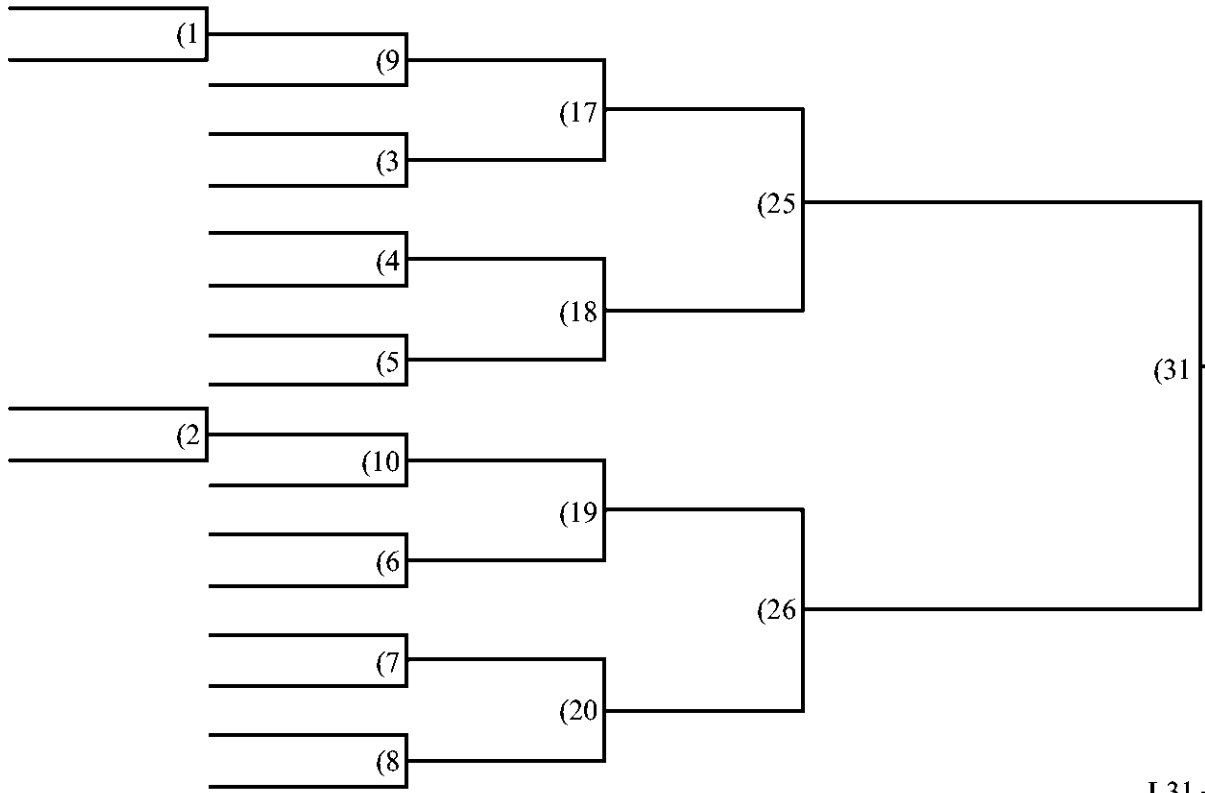

Loser's Bracket

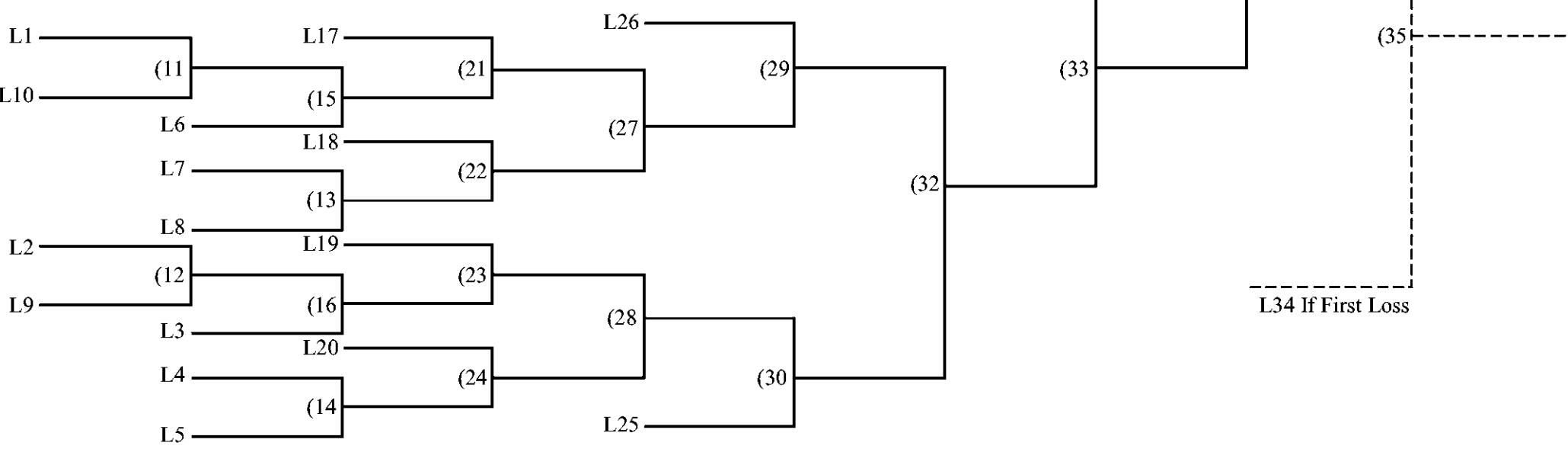

L34 If First Loss

Winner's Bracket

19 Person Double Elimination

Land: _____ Date: _____

Warmaster/Weaponmaster/ _____

Event: _____

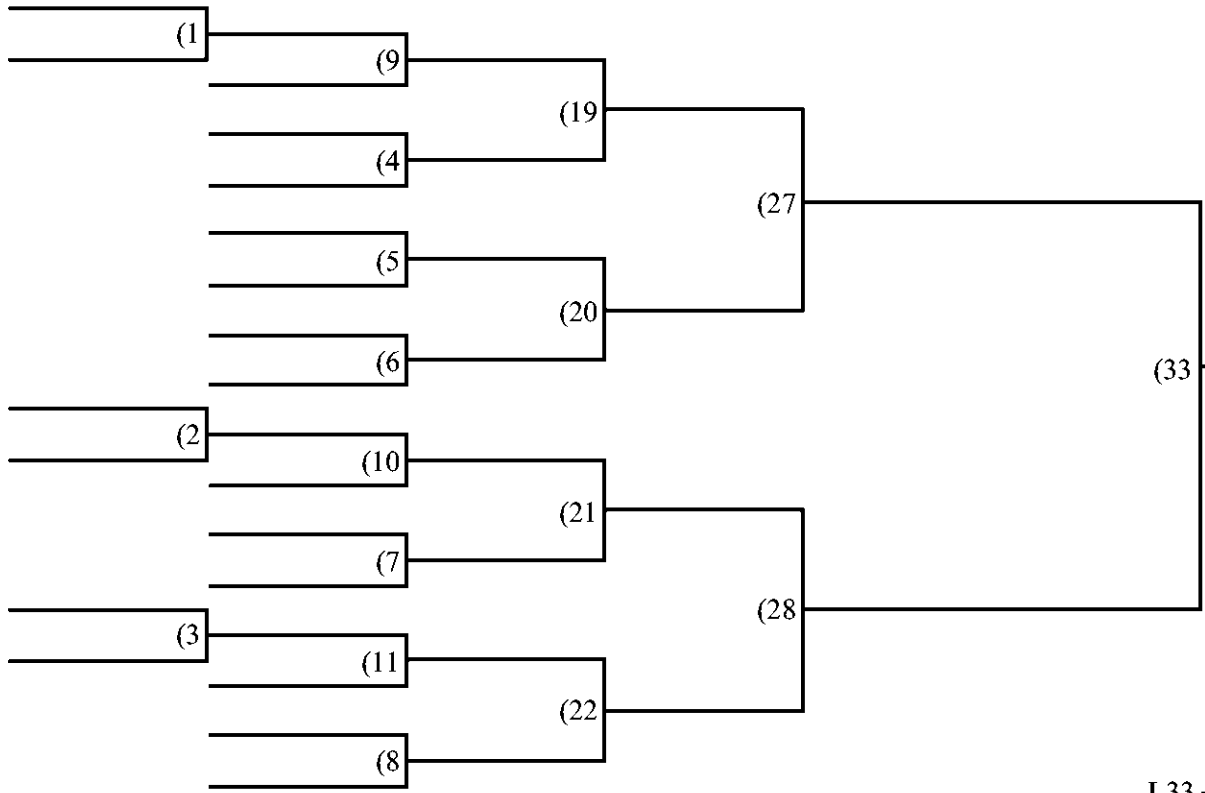

Loser's Bracket

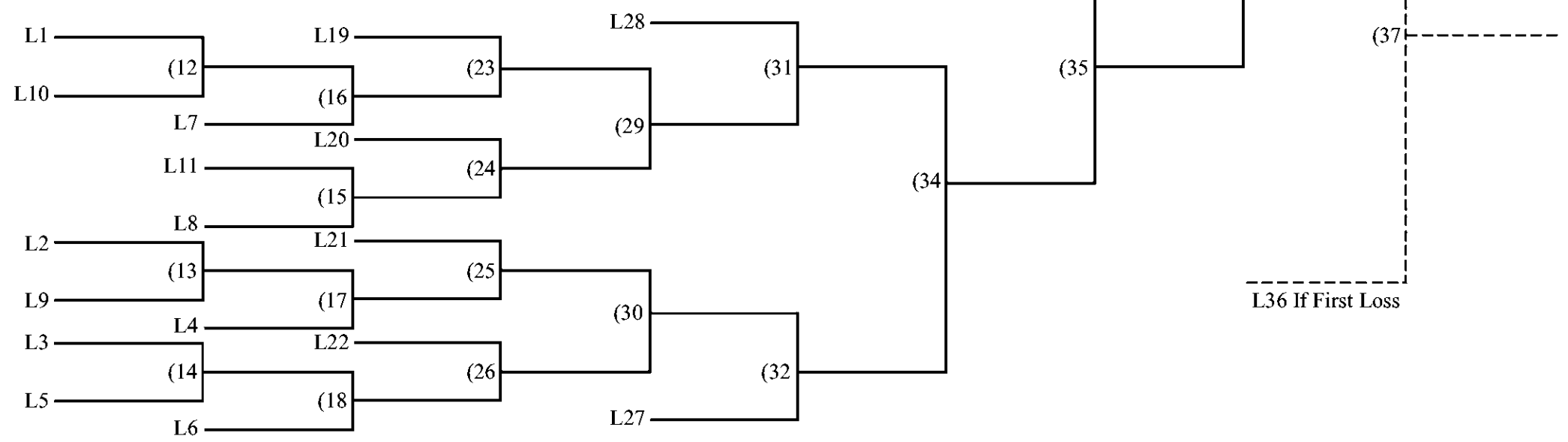

Winner's Bracket

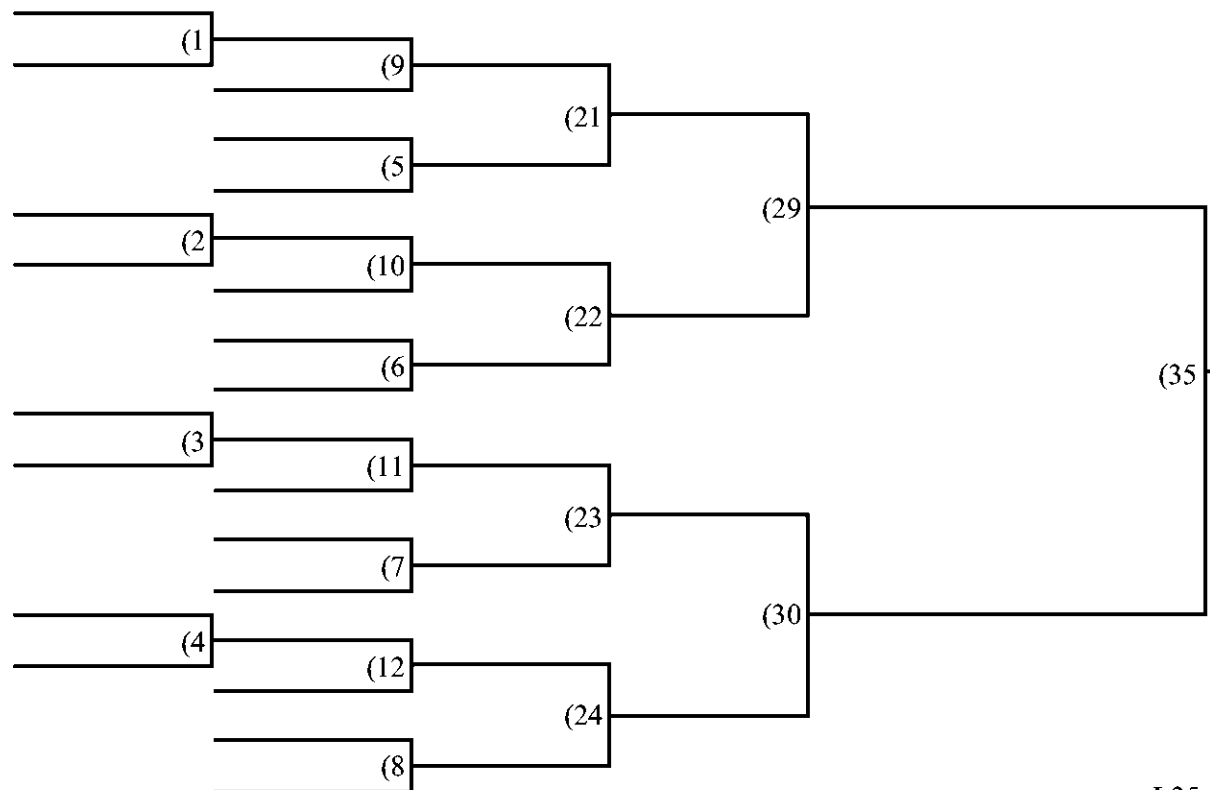

20 Person Double Elimination

Land: _____ Date: _____
 Warmaster/Weaponmaster/ _____
 Event: _____

Loser's Bracket

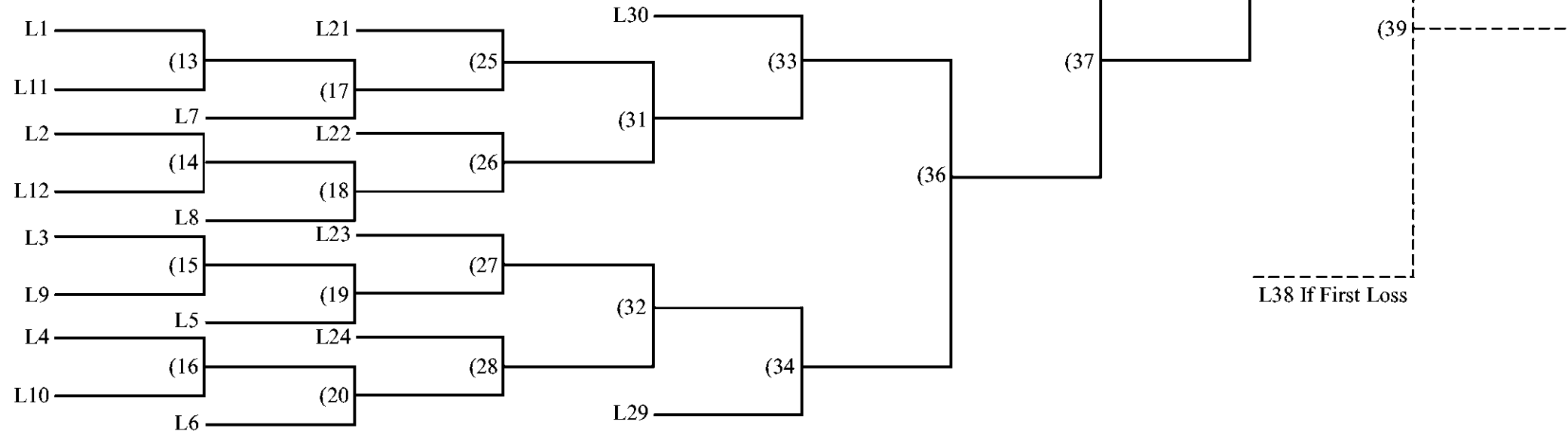

Winner's Bracket

21 Person Double Elimination

Land: _____ Date: _____

Warmaster/Weaponmaster/ _____

Event: _____

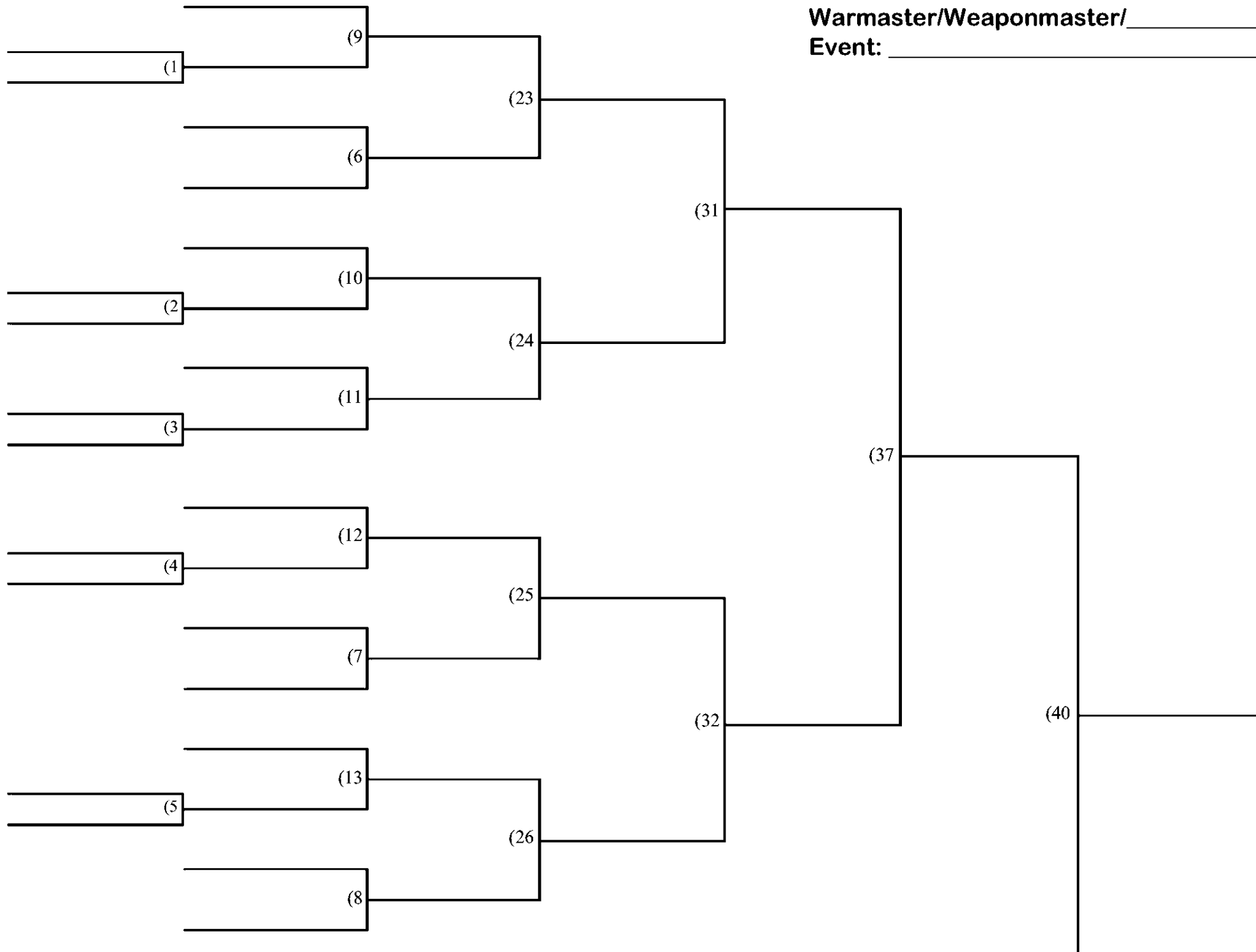

Loser's Bracket

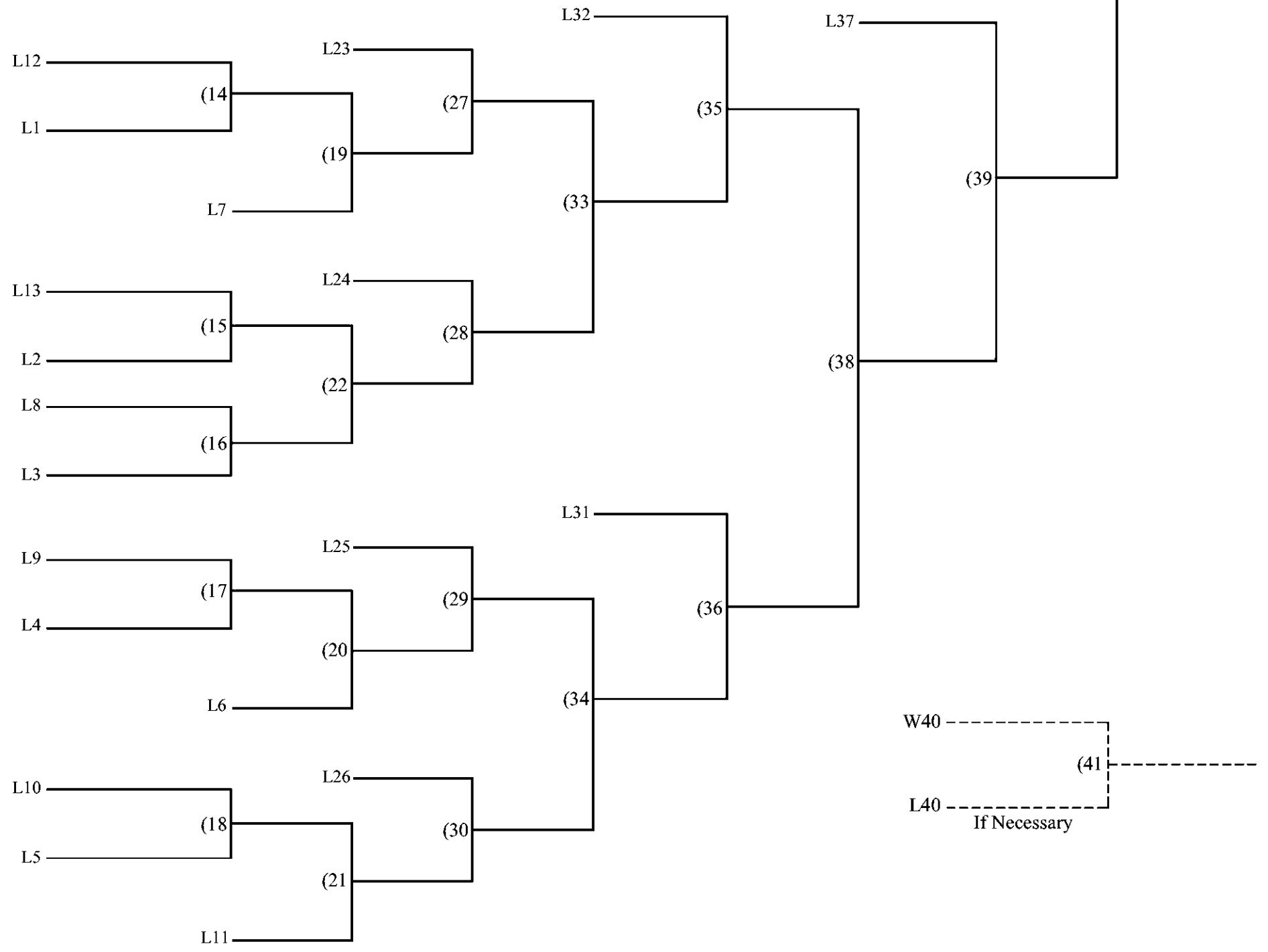

Winner's Bracket

22 Person Double Elimination

Land: _____ Date: _____

Warmaster/Weaponmaster/ _____

Event: _____

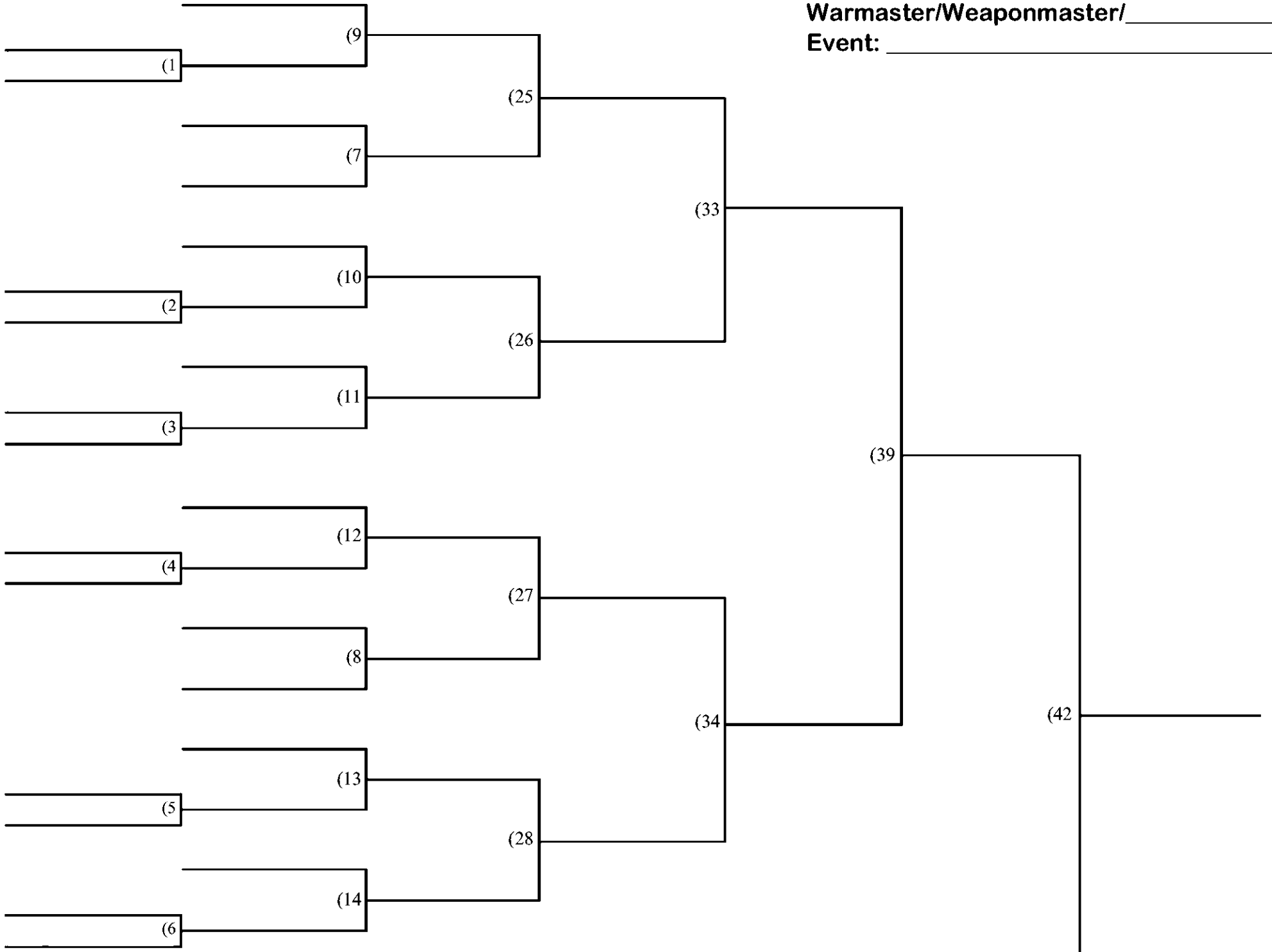

Loser's Bracket

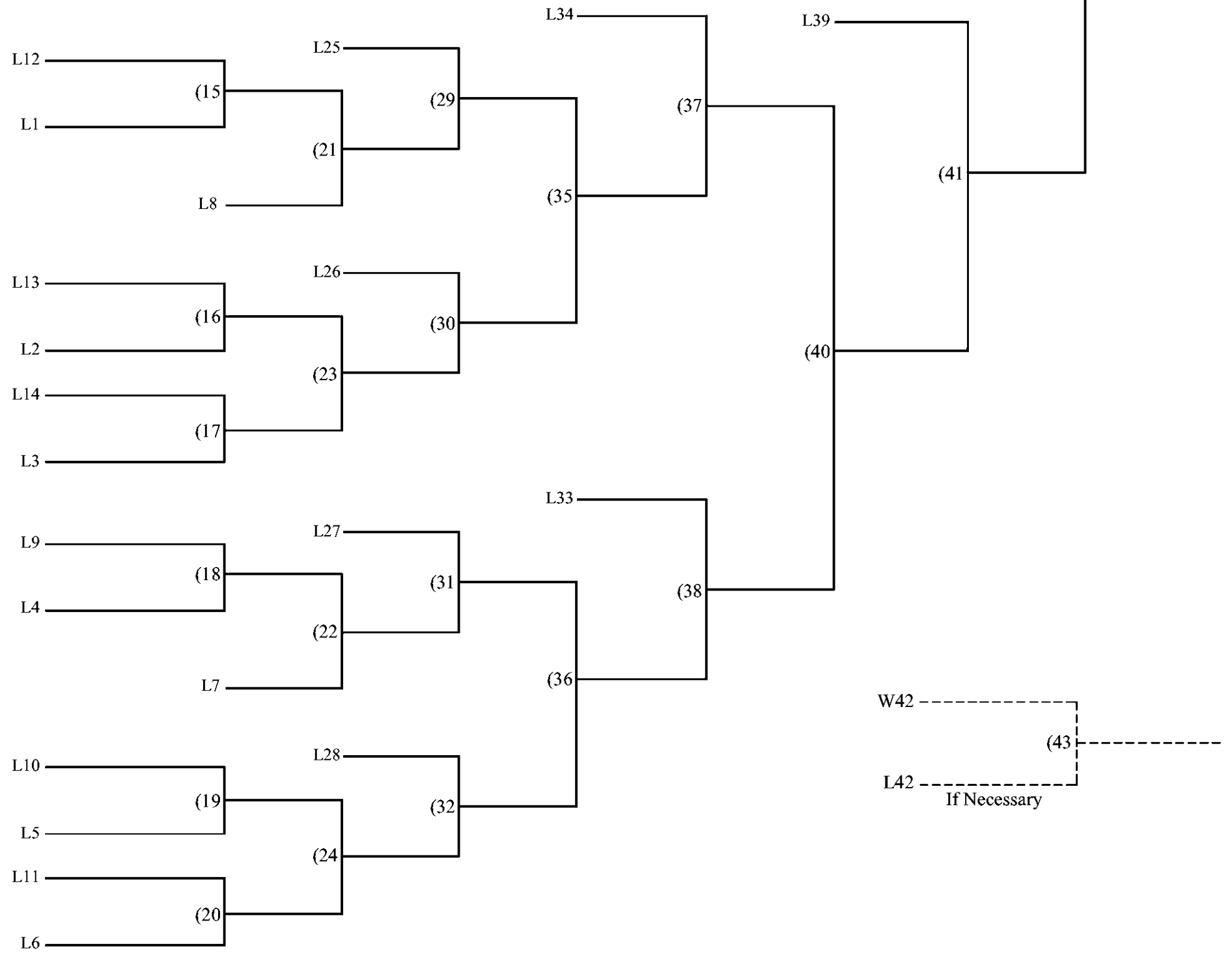

Winner's Bracket

23 Person Double Elimination

Land: _____ Date: _____

Warmaster/Weaponmaster/ _____

Event: _____

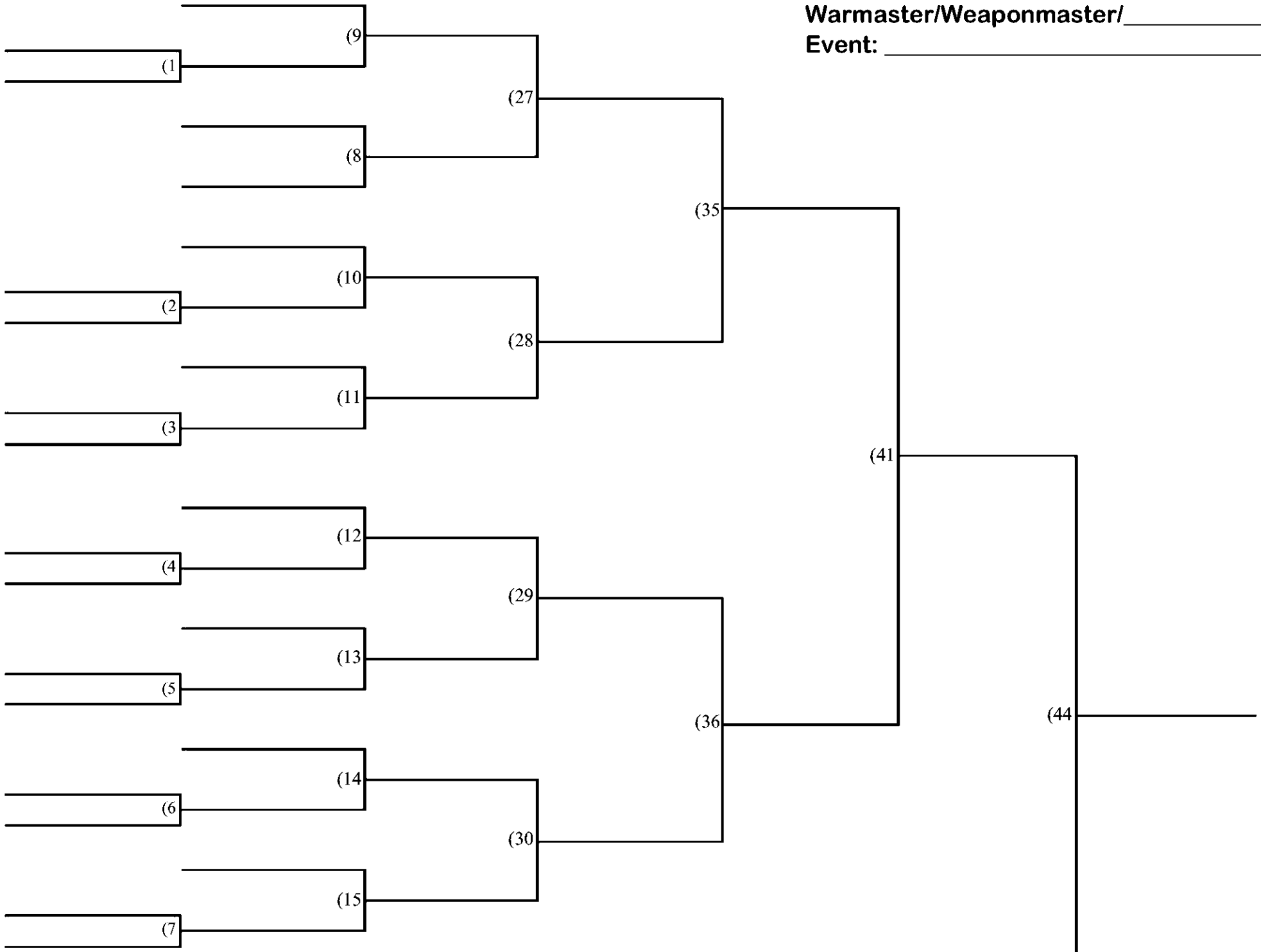

Loser's Bracket

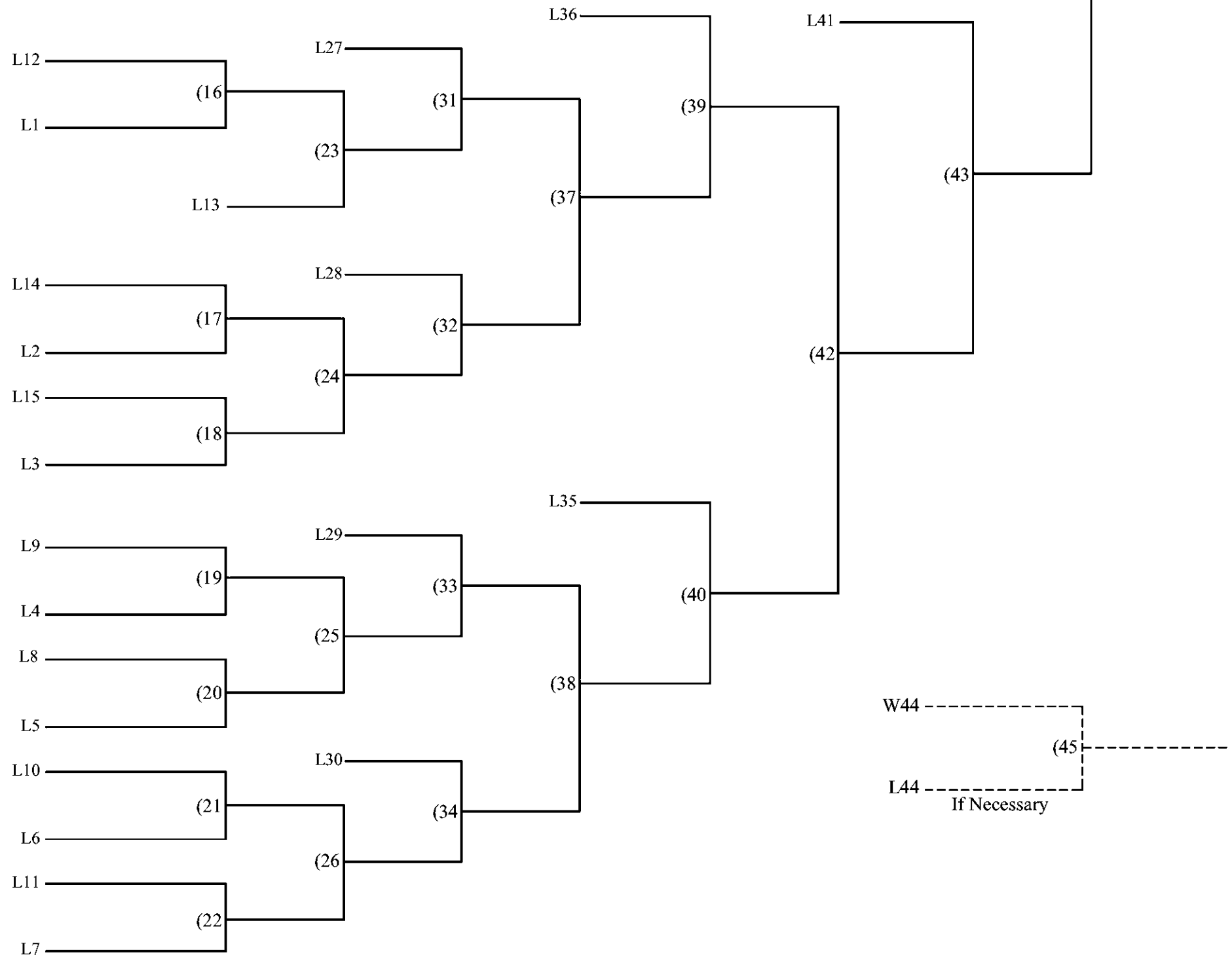

Land: _____ Date: _____

Warmaster/Weaponmaster/ _____

Event: _____



Loser's Bracket

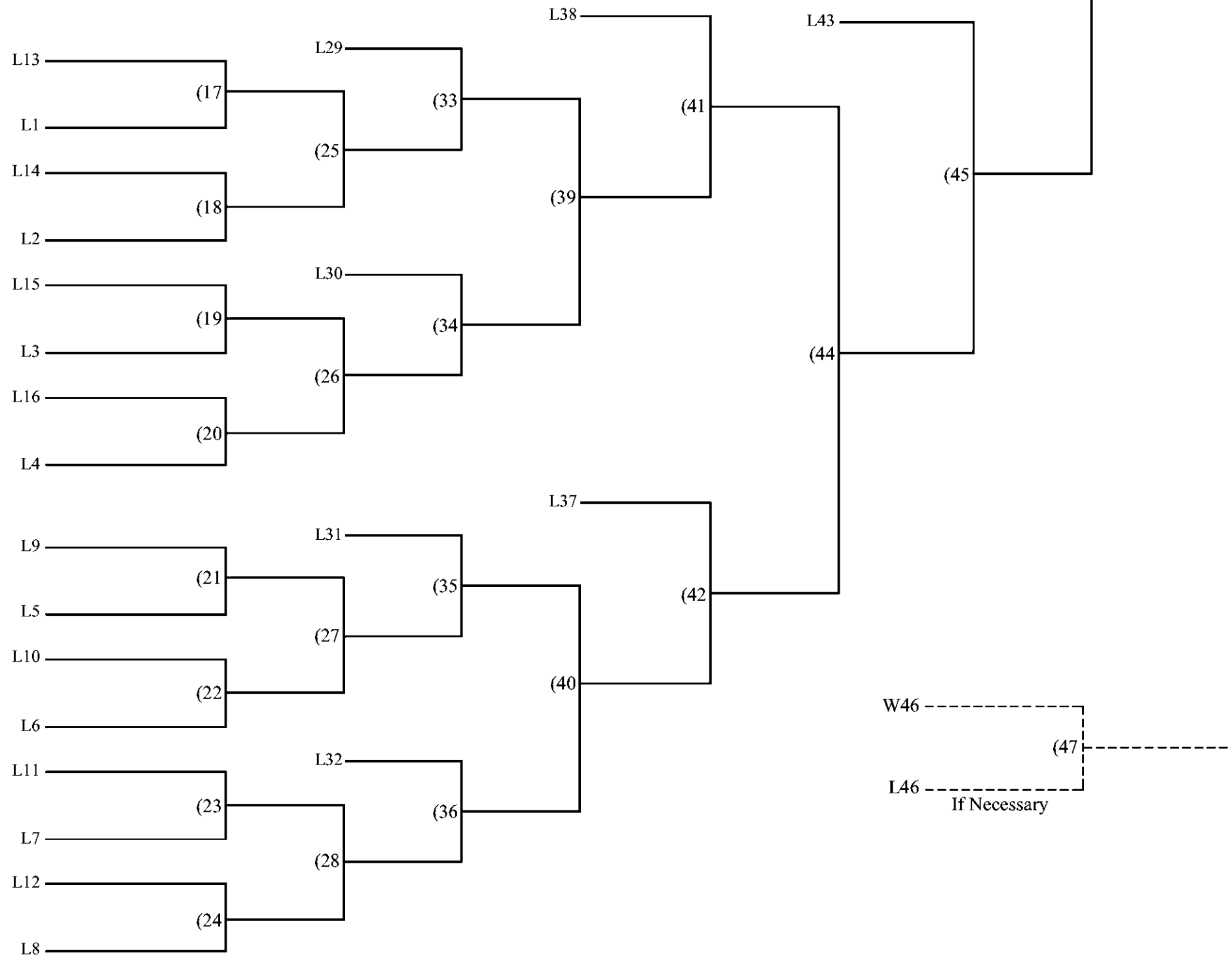

Winner's Bracket

25 Person Double Elimination

Land: _____ Date: _____

Warmaster/Weaponmaster/ _____

Event: _____

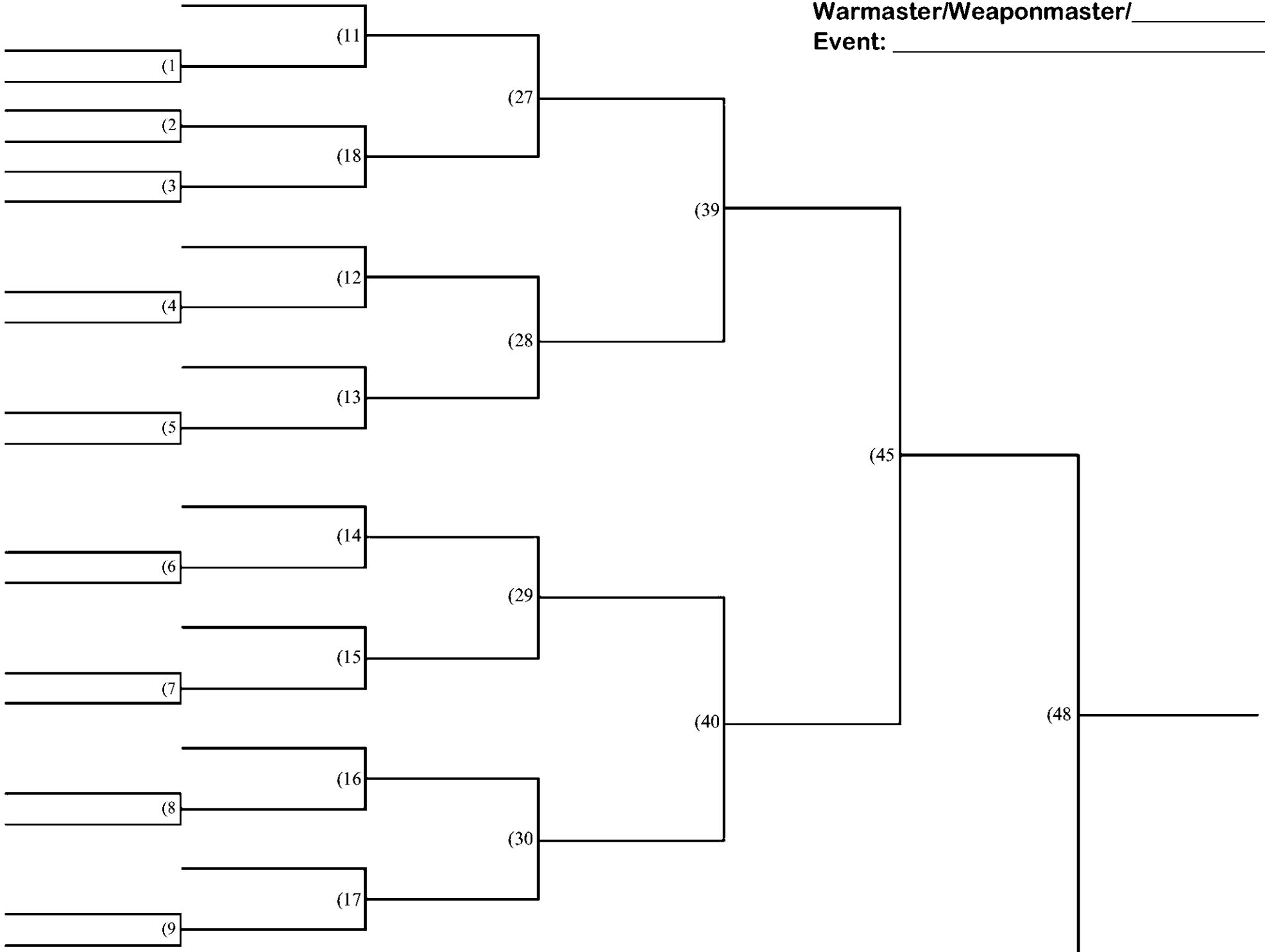

Loser's Bracket

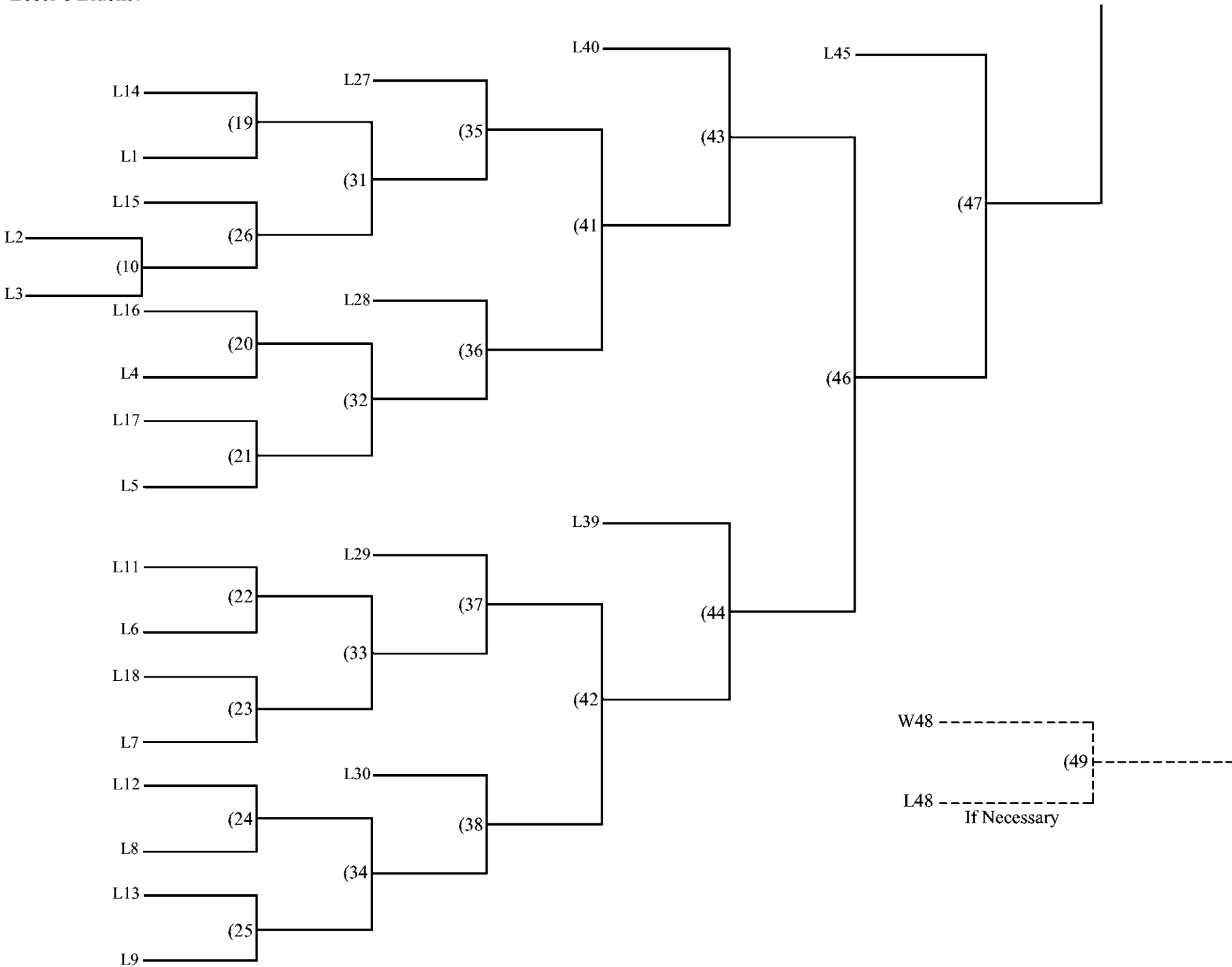

Winner's Bracket

26 Person Double Elimination

Land: _____ Date: _____

Warmaster/Weaponmaster/ _____

Event: _____

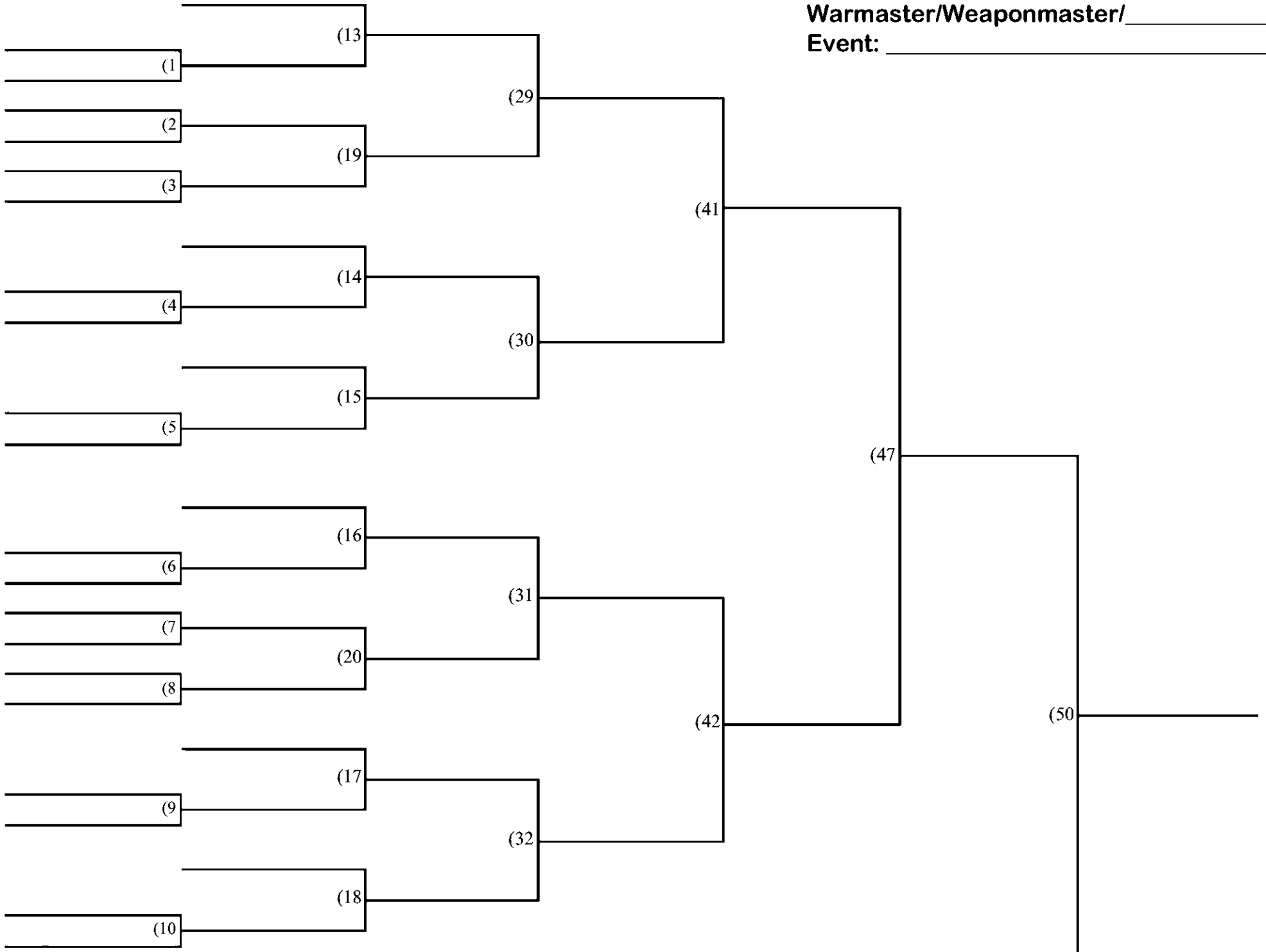

Loser's Bracket

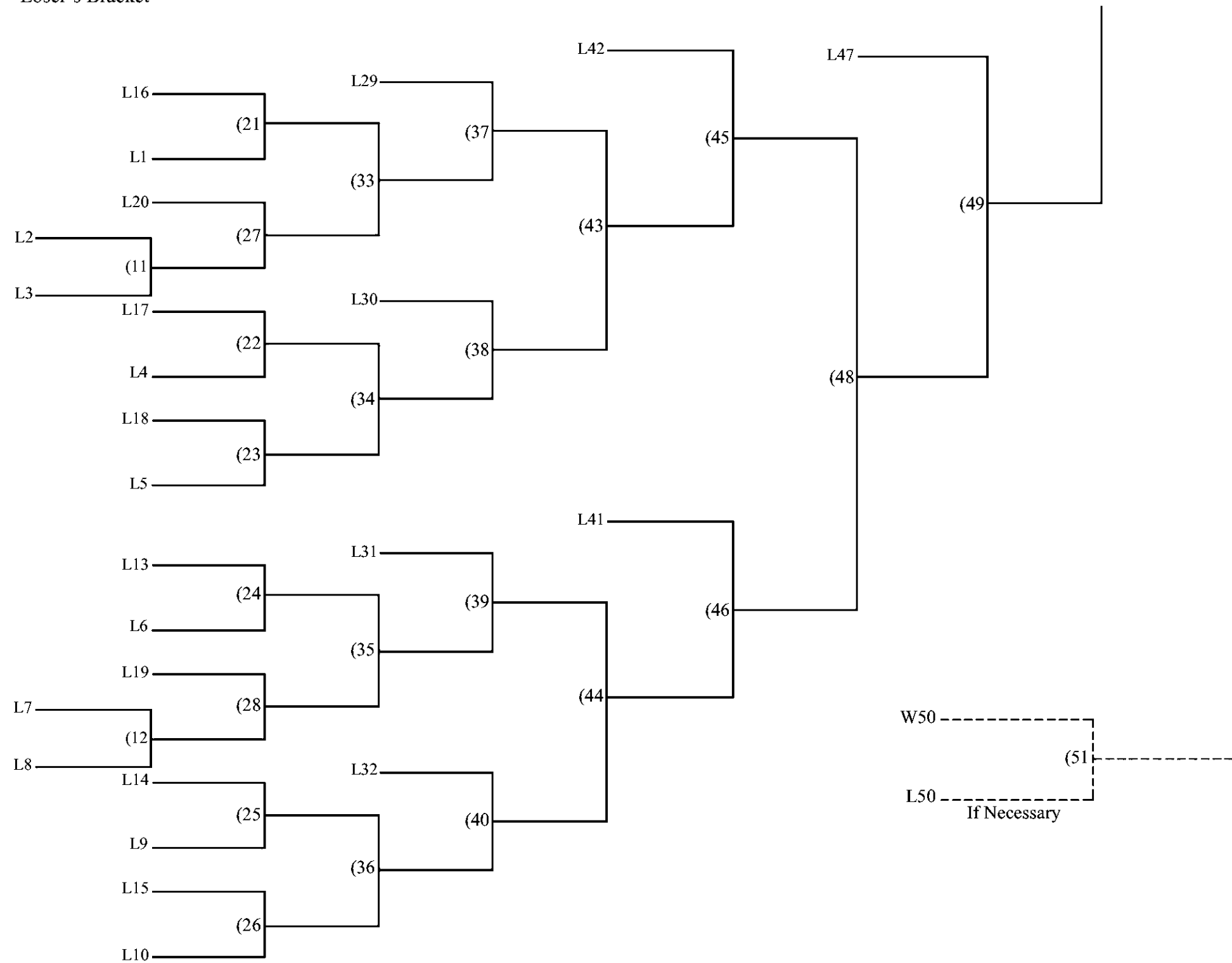

Winner's Bracket

27 Person Double Elimination

Land: _____ Date: _____

Warmaster/Weaponmaster/ _____

Event: _____

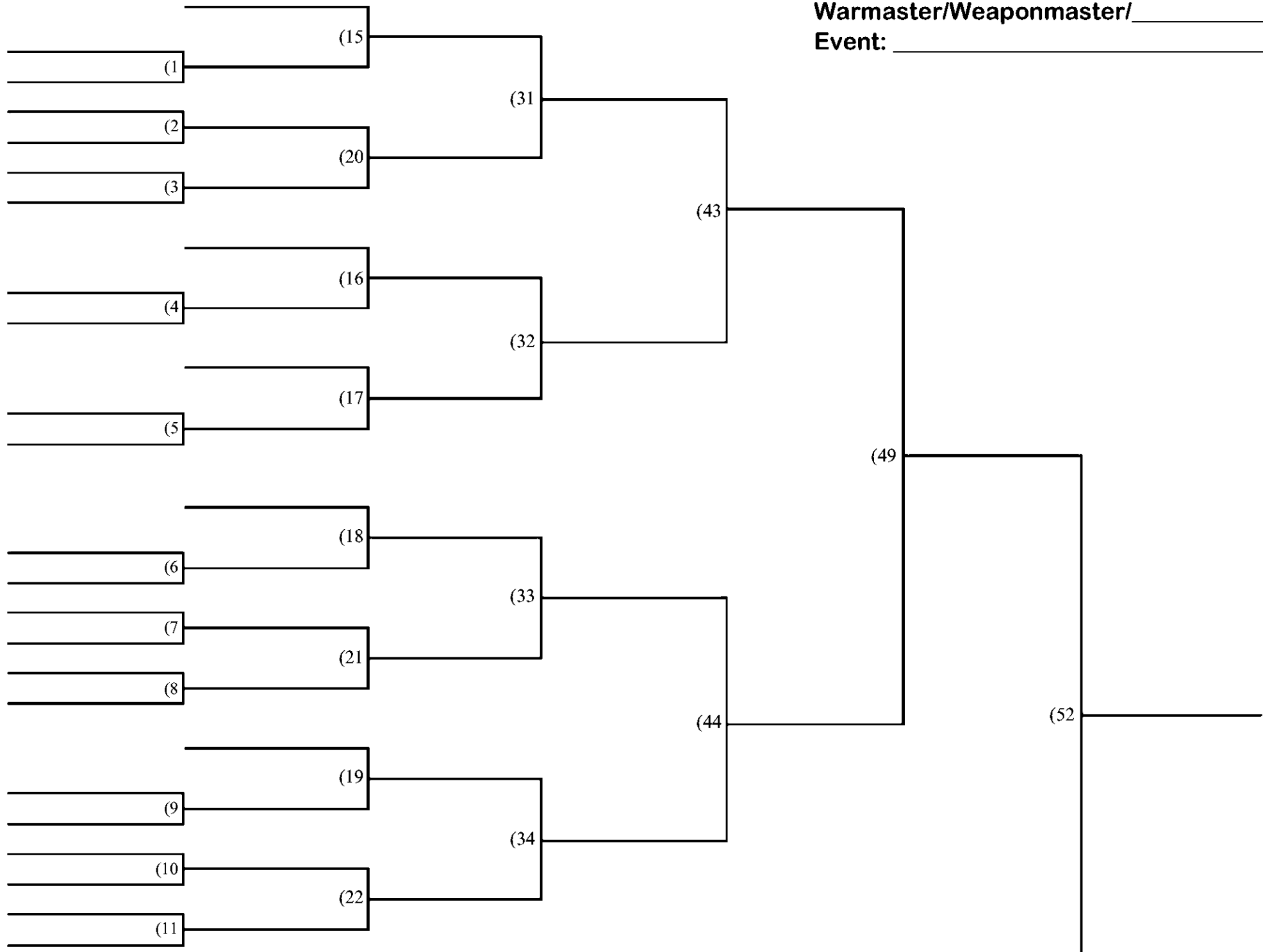

Loser's Bracket

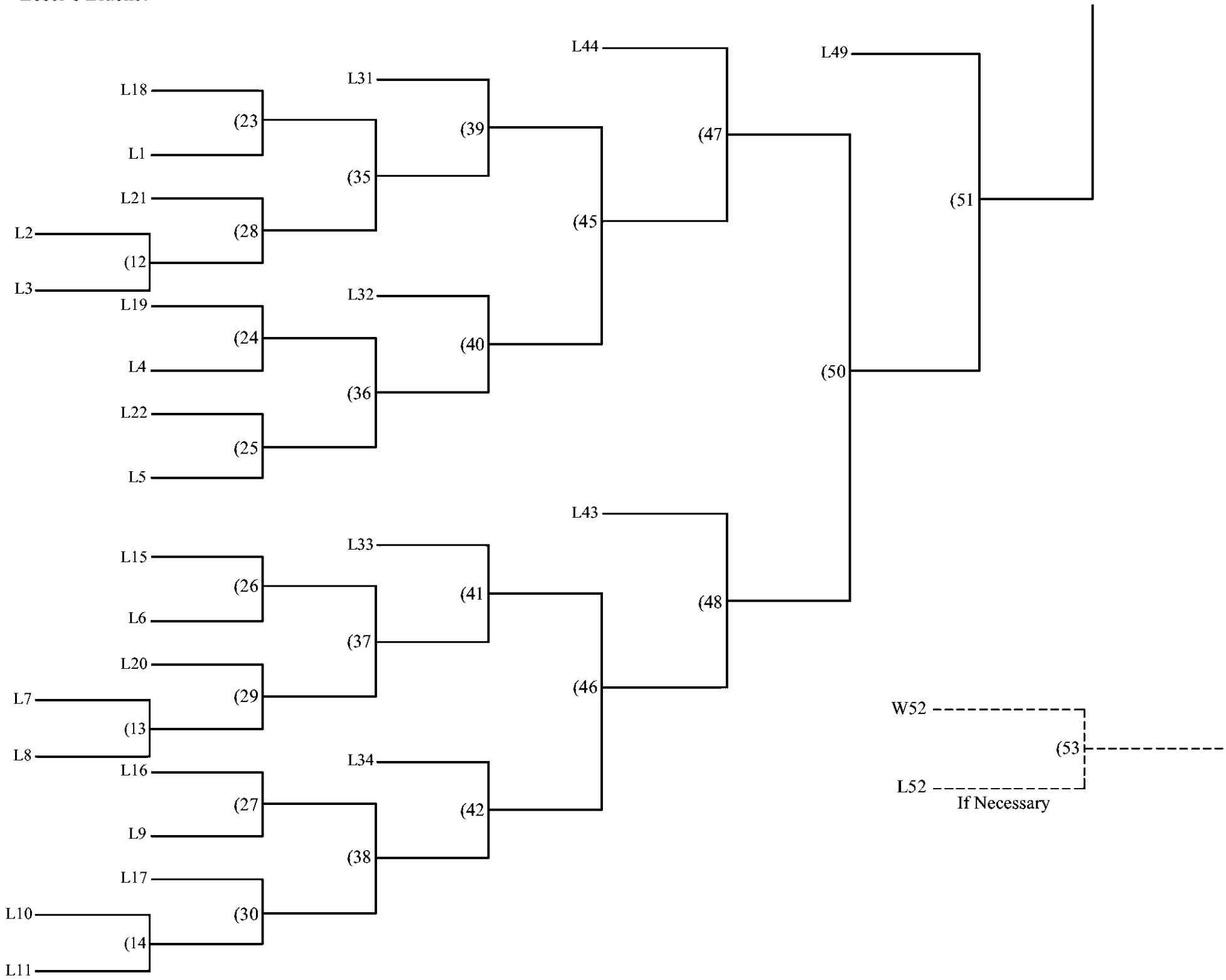

Winner's Bracket

28 Person Double Elimination

Land: _____ Date: _____

Warmaster/Weaponmaster/ _____

Event: _____

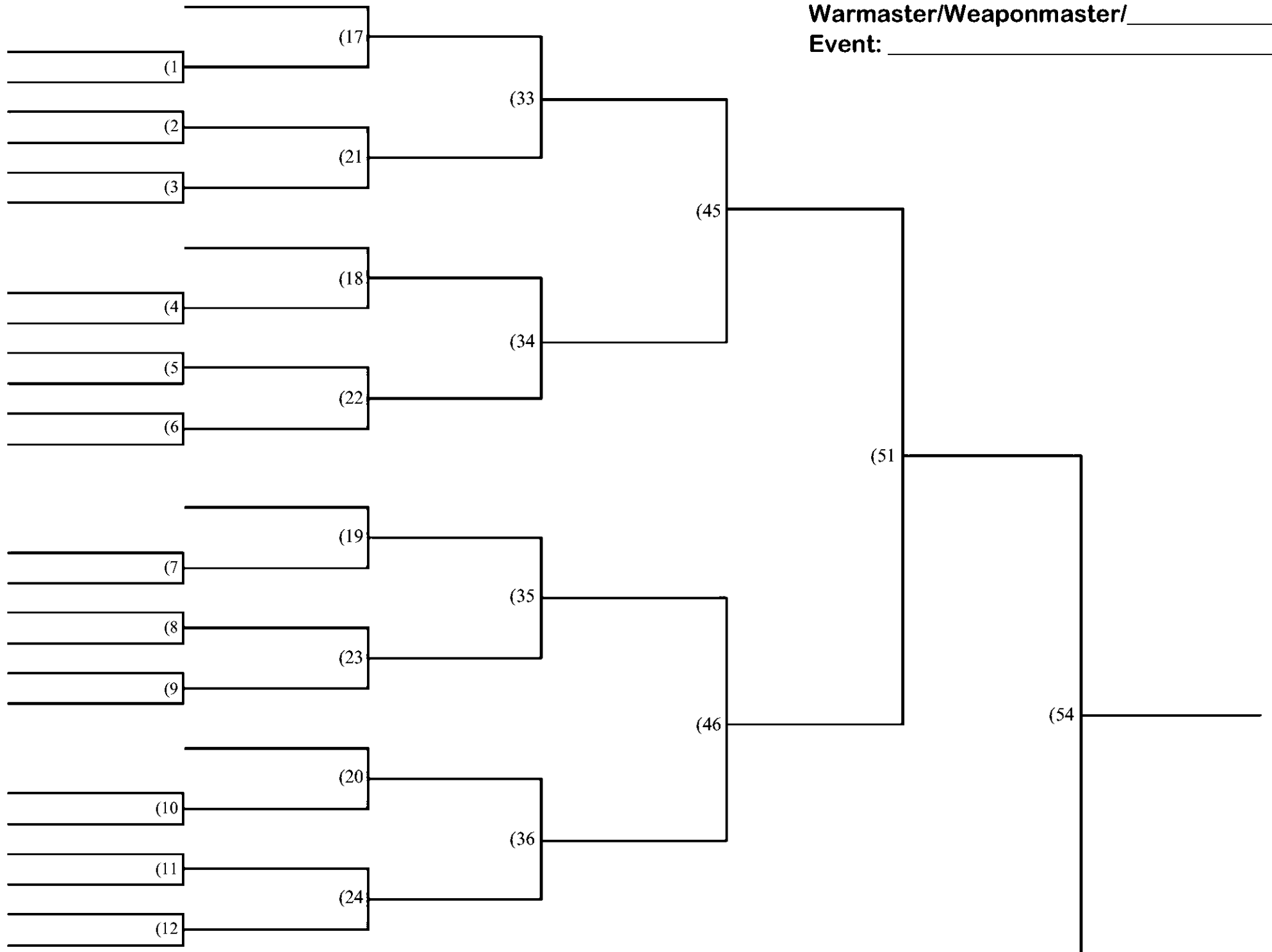

Loser's Bracket

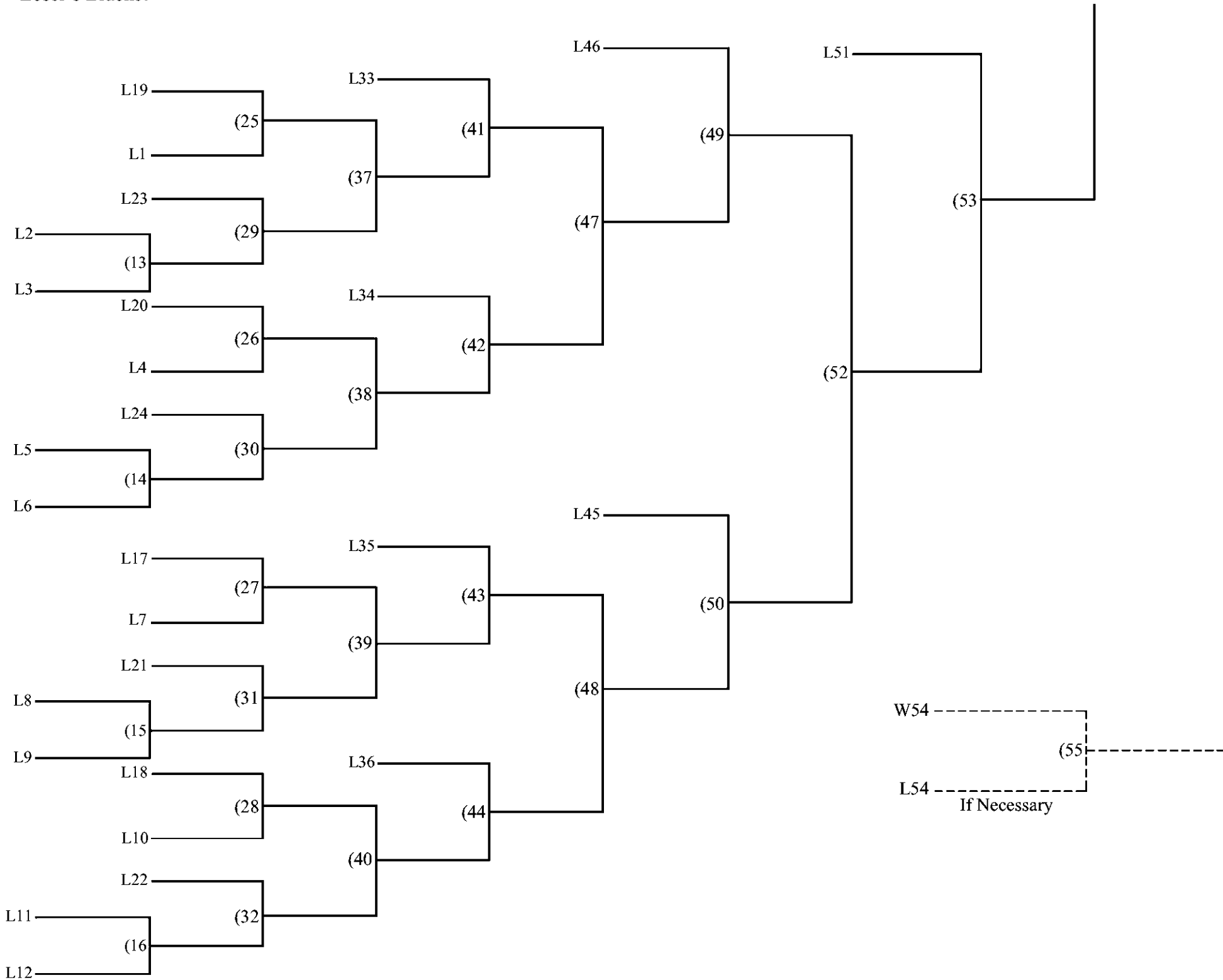

Winner's Bracket

29 Person Double Elimination

Land: _____ Date: _____

Warmaster/Weaponmaster/ _____

Event: _____

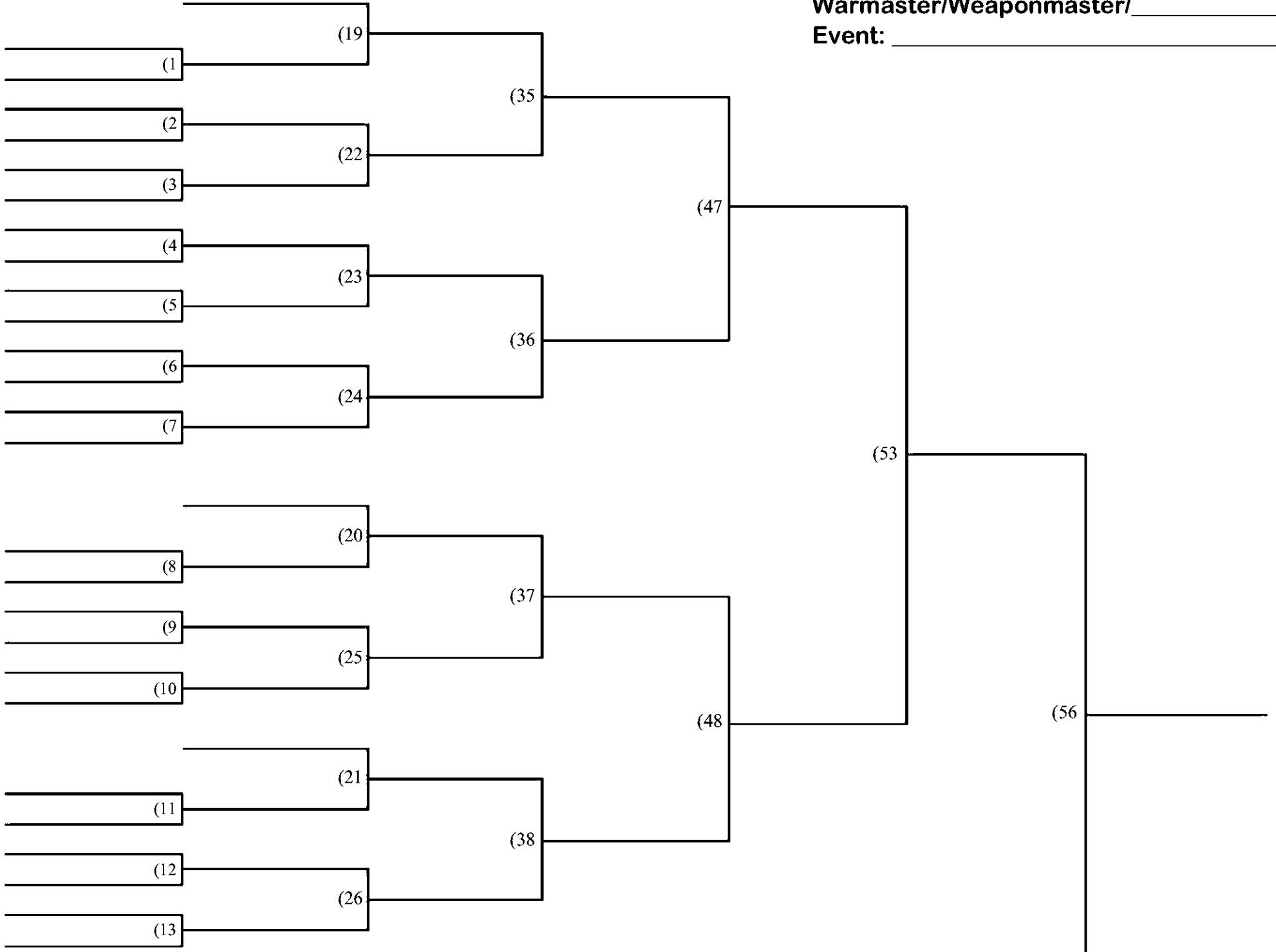

Loser's Bracket

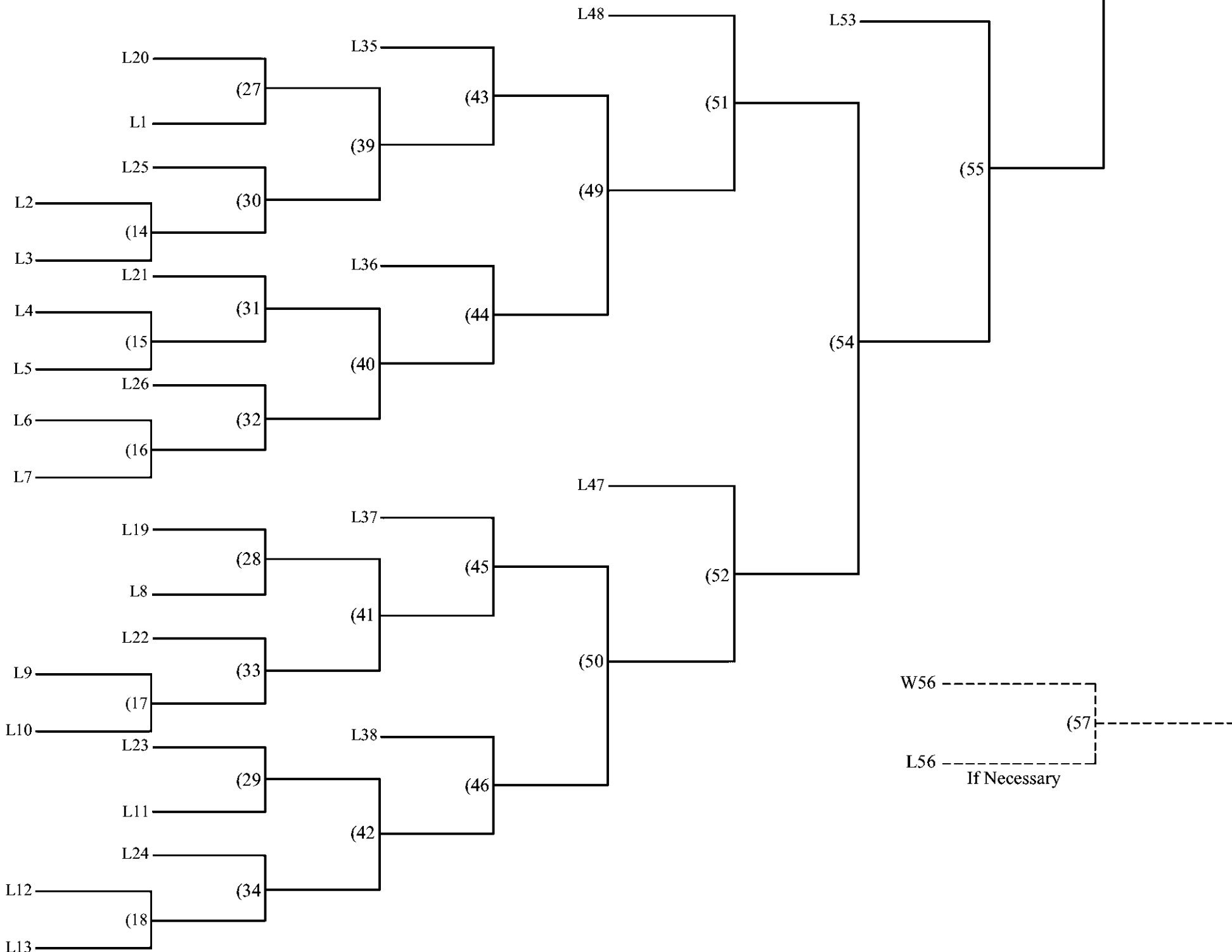

Winner's Bracket

30 Person Double Elimination

Land: _____ Date: _____

Warmaster/Weaponmaster/ _____

Event: _____

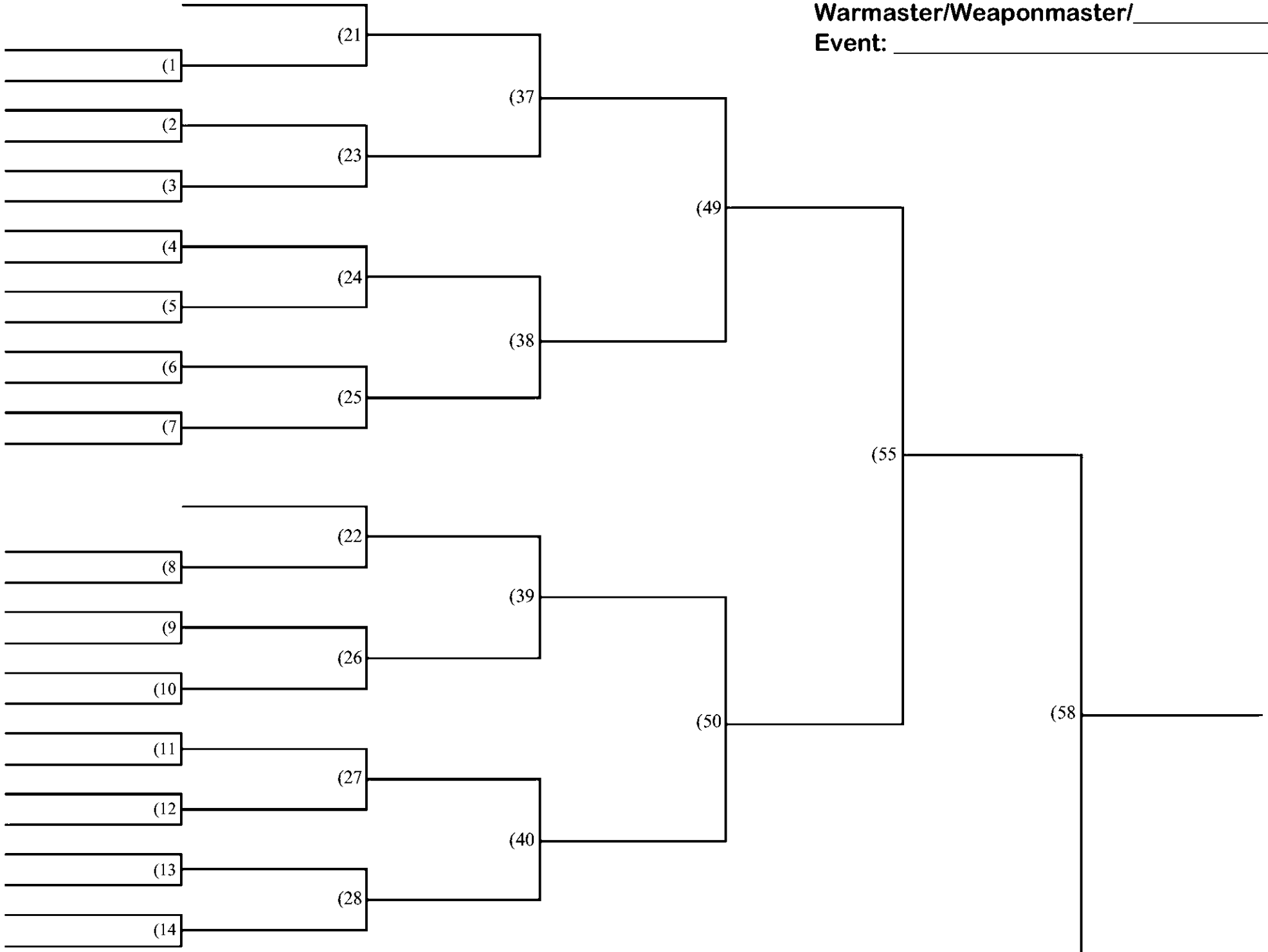

Loser's Bracket

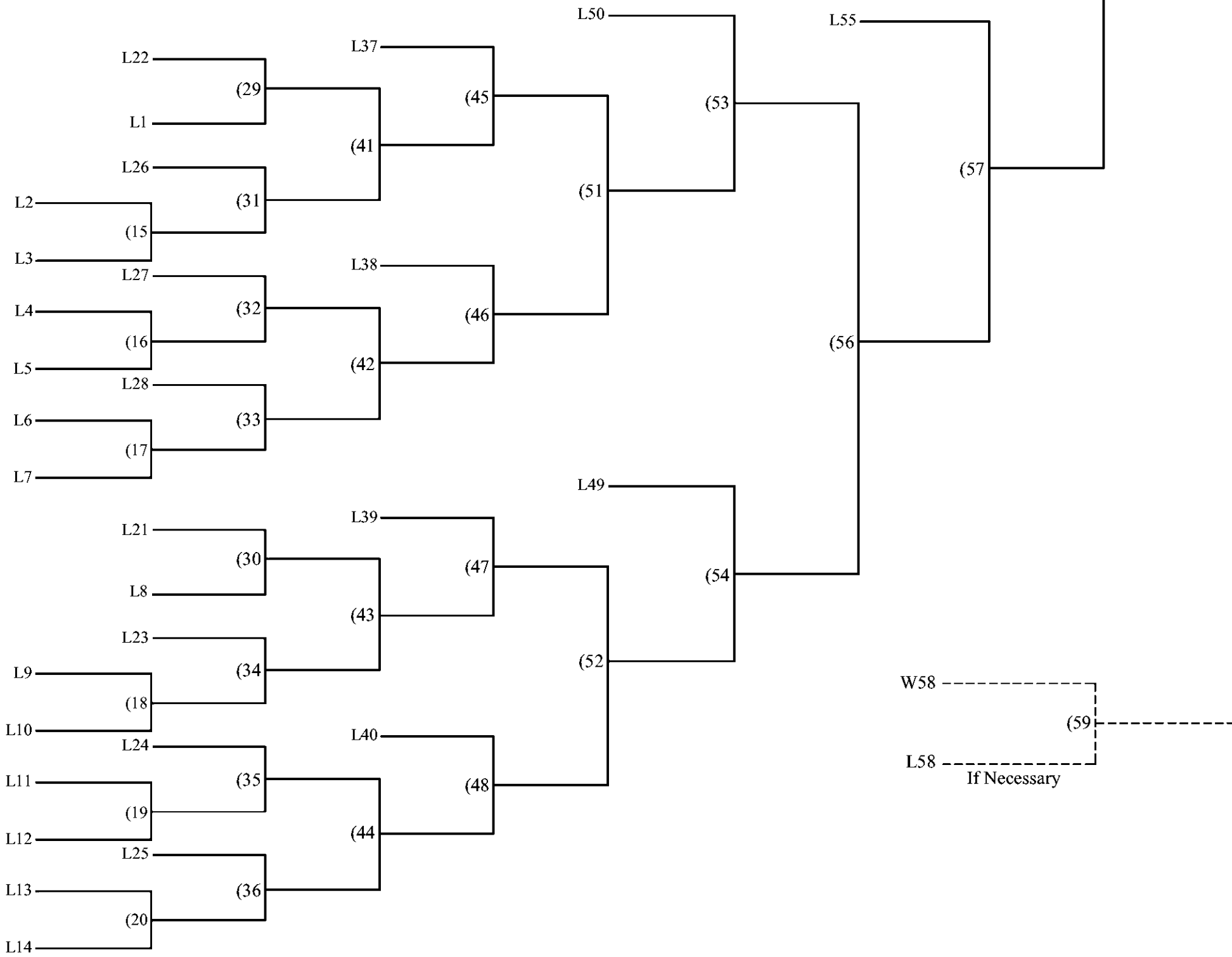

Winner's Bracket

31 Person Double Elimination

Land: _____ Date: _____

Warmaster/Weaponmaster/ _____

Event: _____

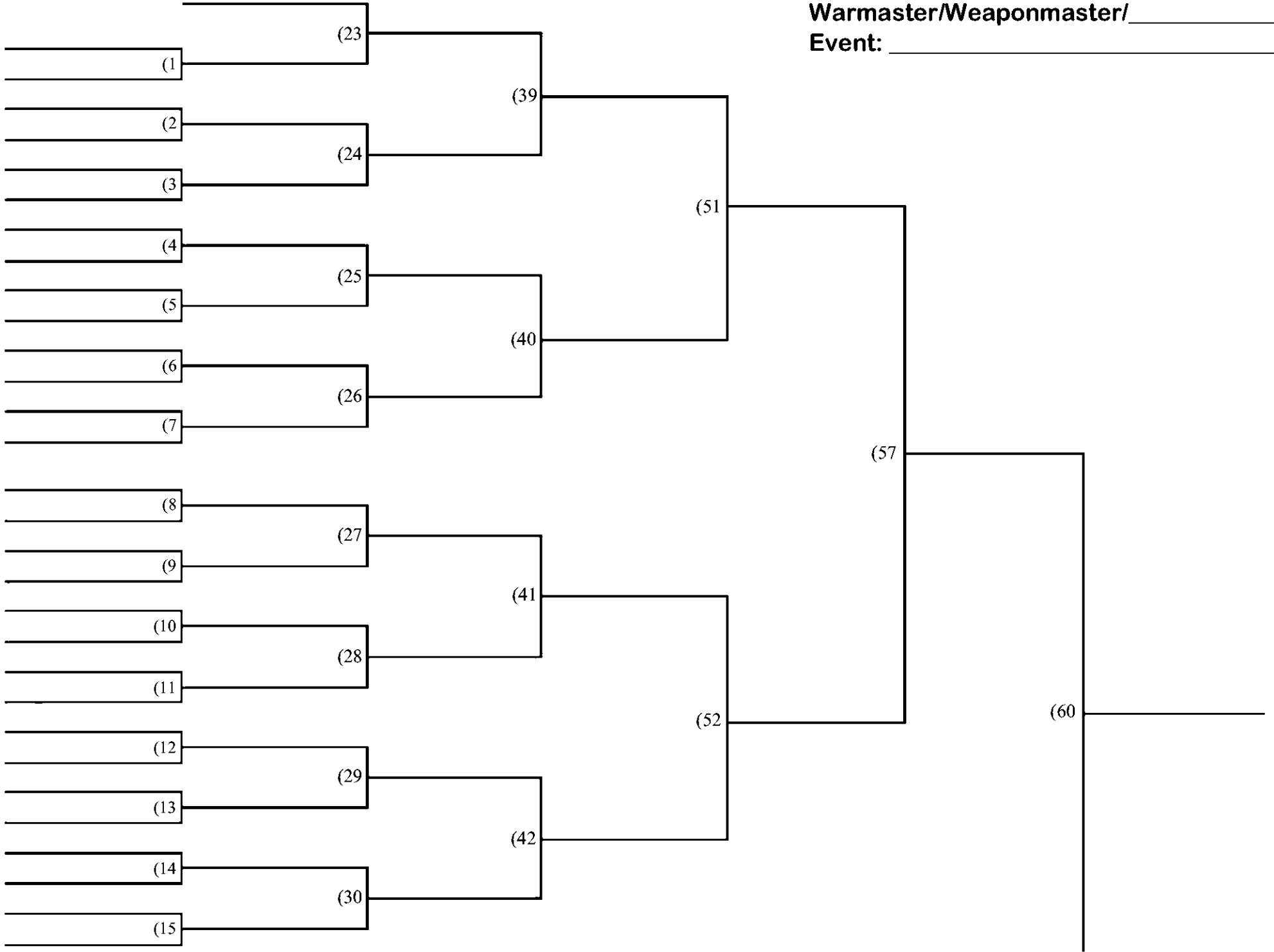

Loser's Bracket

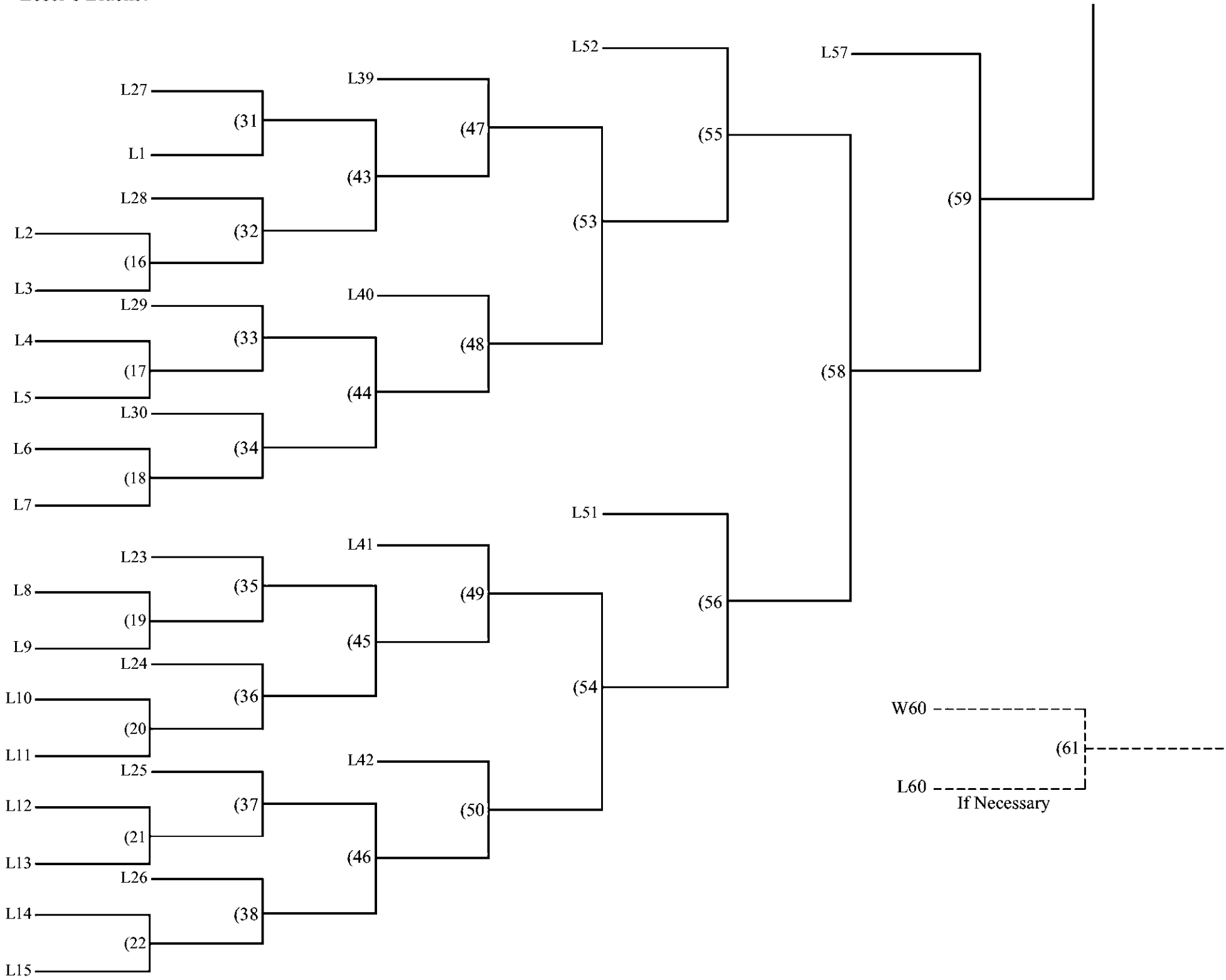

Winner's Bracket

32 Person Double Elimination

Land: _____ Date: _____

Warmaster/Weaponmaster/ _____

Event: _____

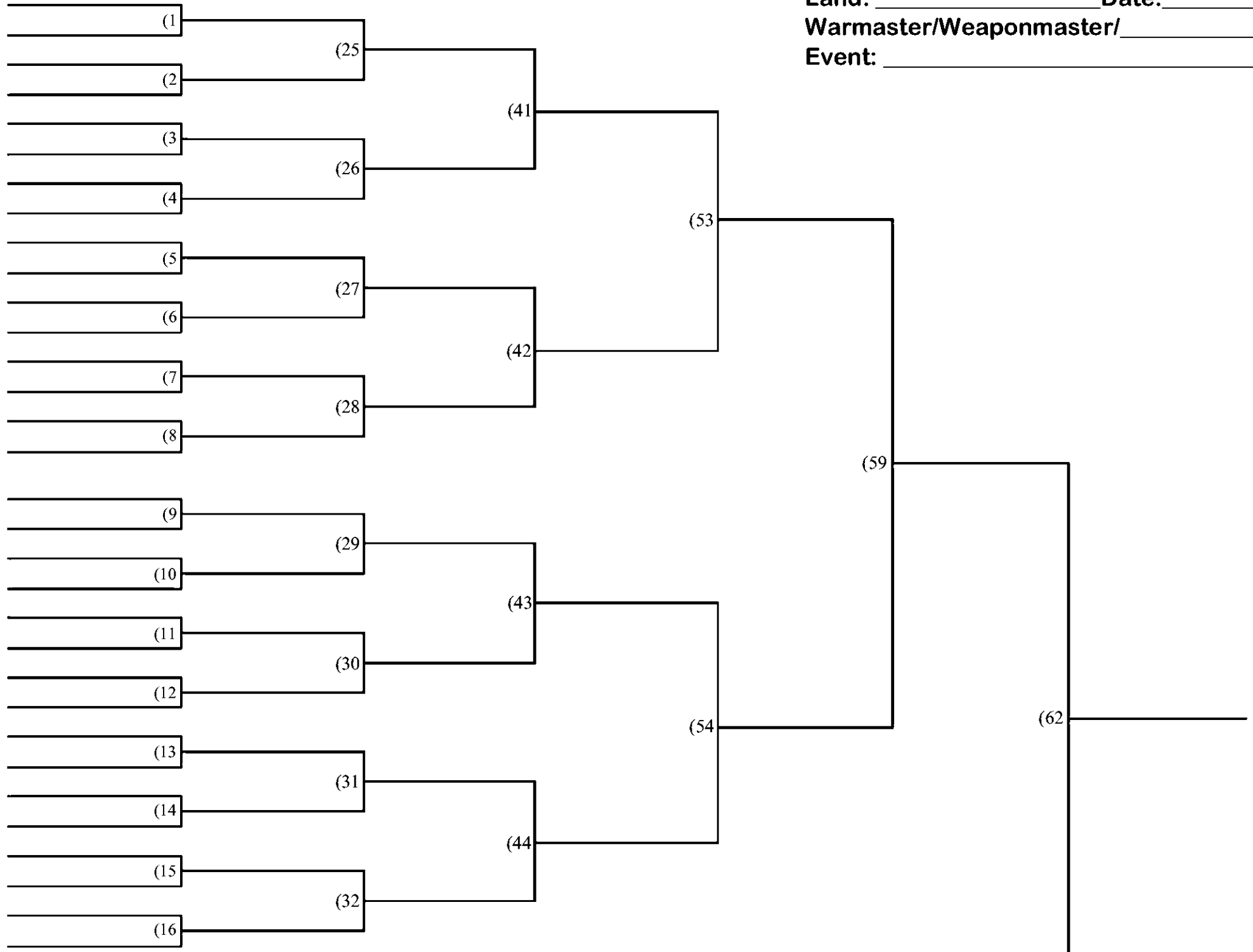

Loser's Bracket

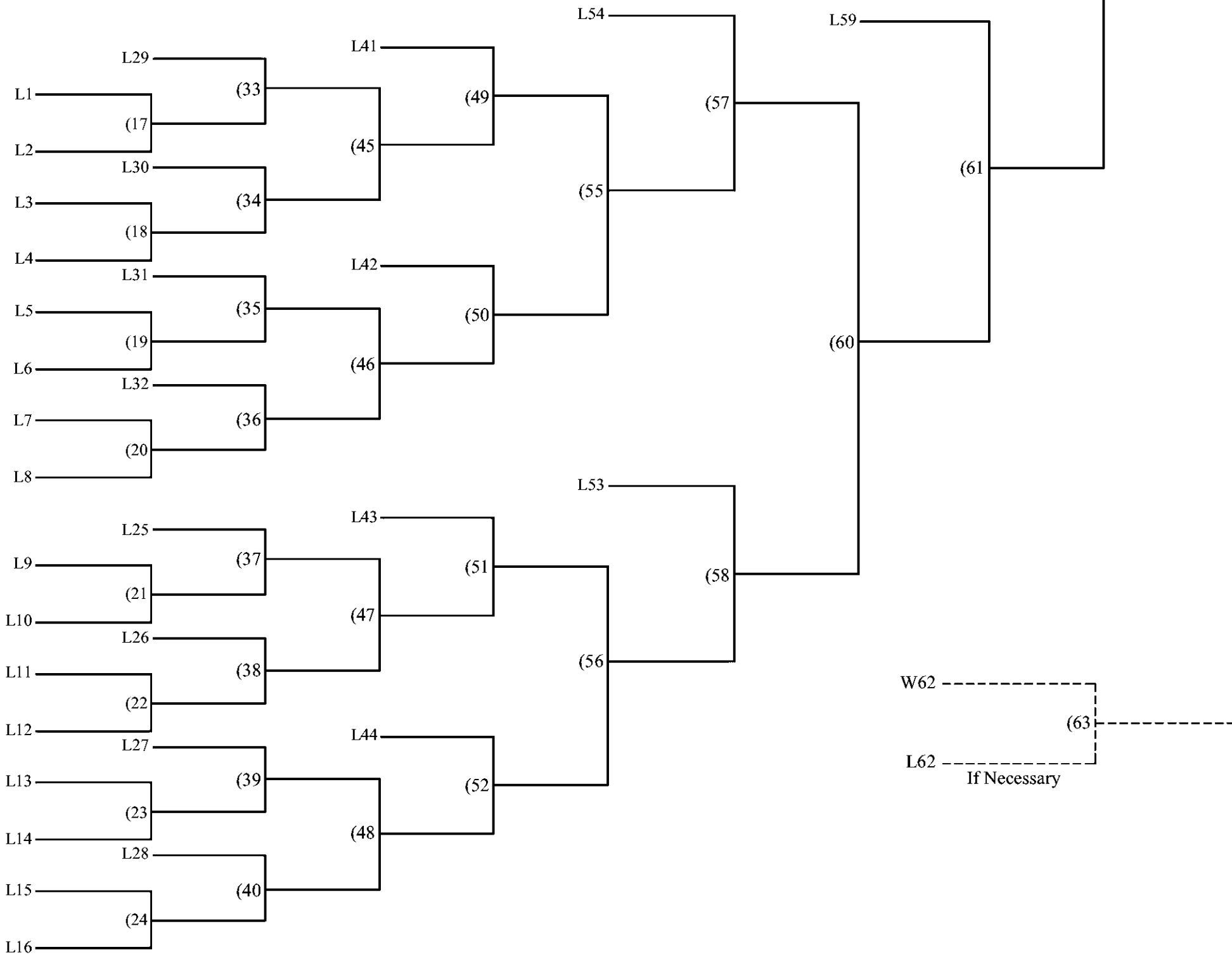

33 Person Double Elimination

Event: _____

Winner's Bracket

Champion

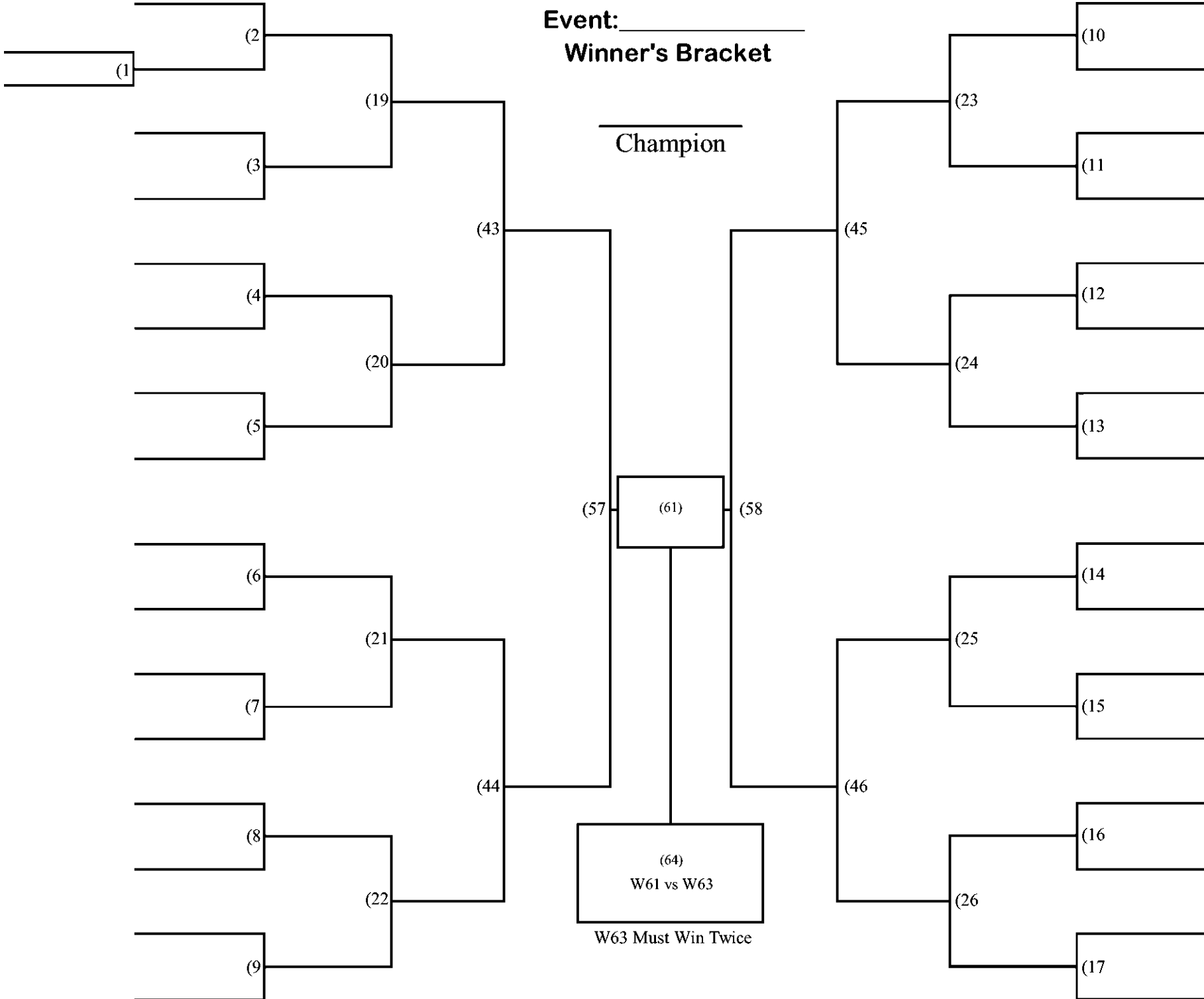

Date: _____ Land: _____ Tourney: _____

Loser's Bracket

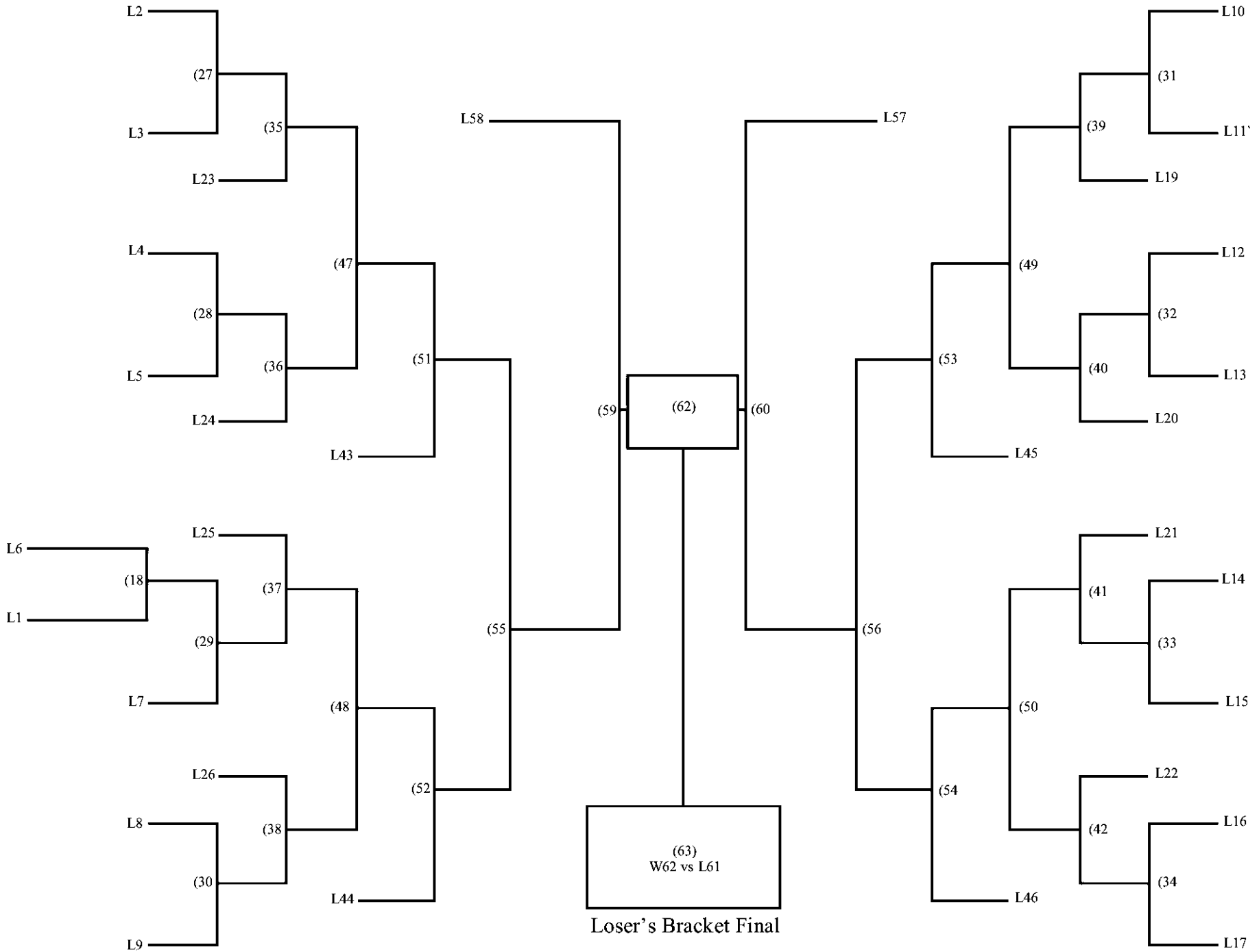

34 Person Double Elimination

Winner's Bracket

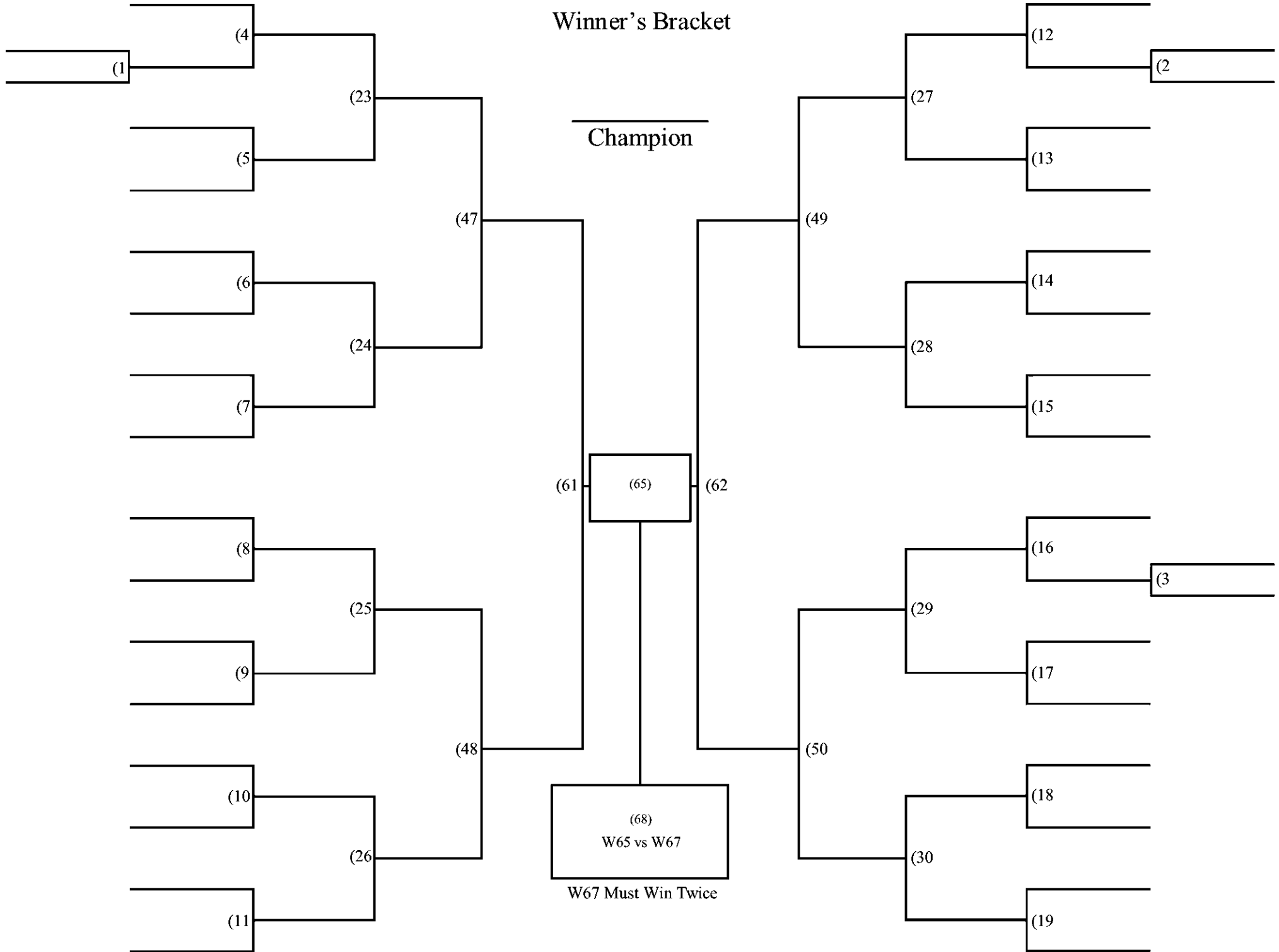

Loser's Bracket

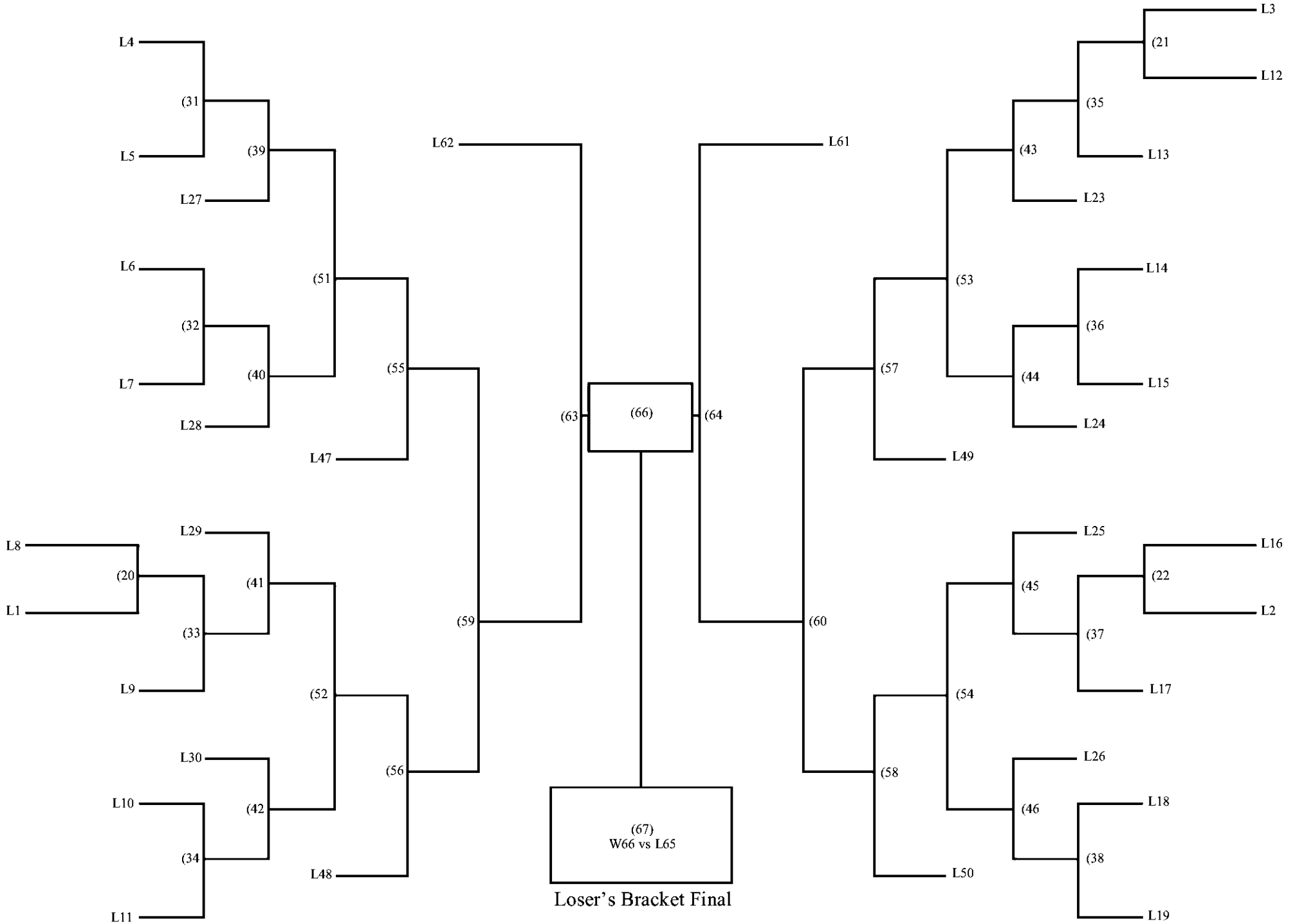

35 Person Double Elimination

Winner's Bracket

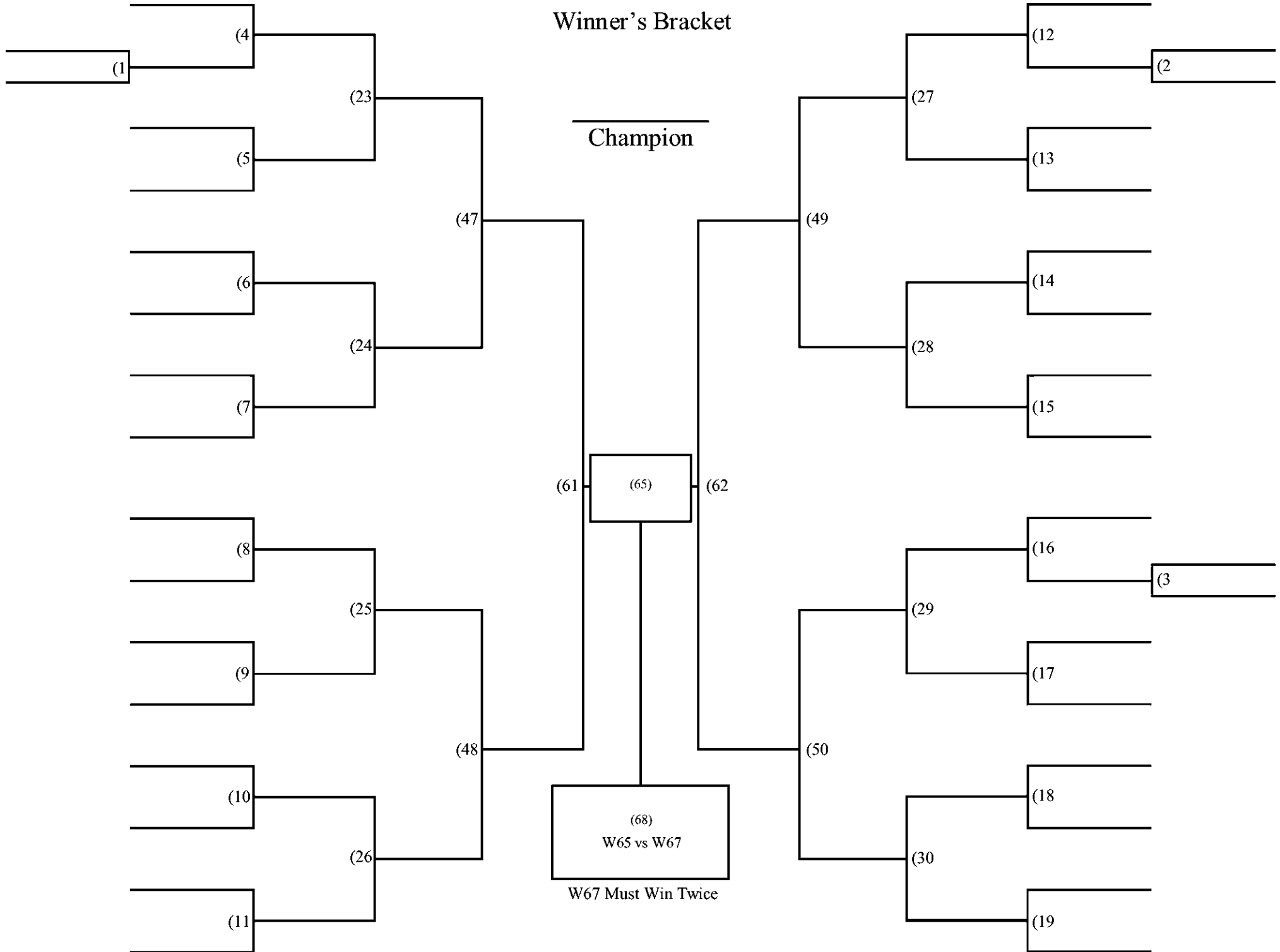

Loser's Bracket

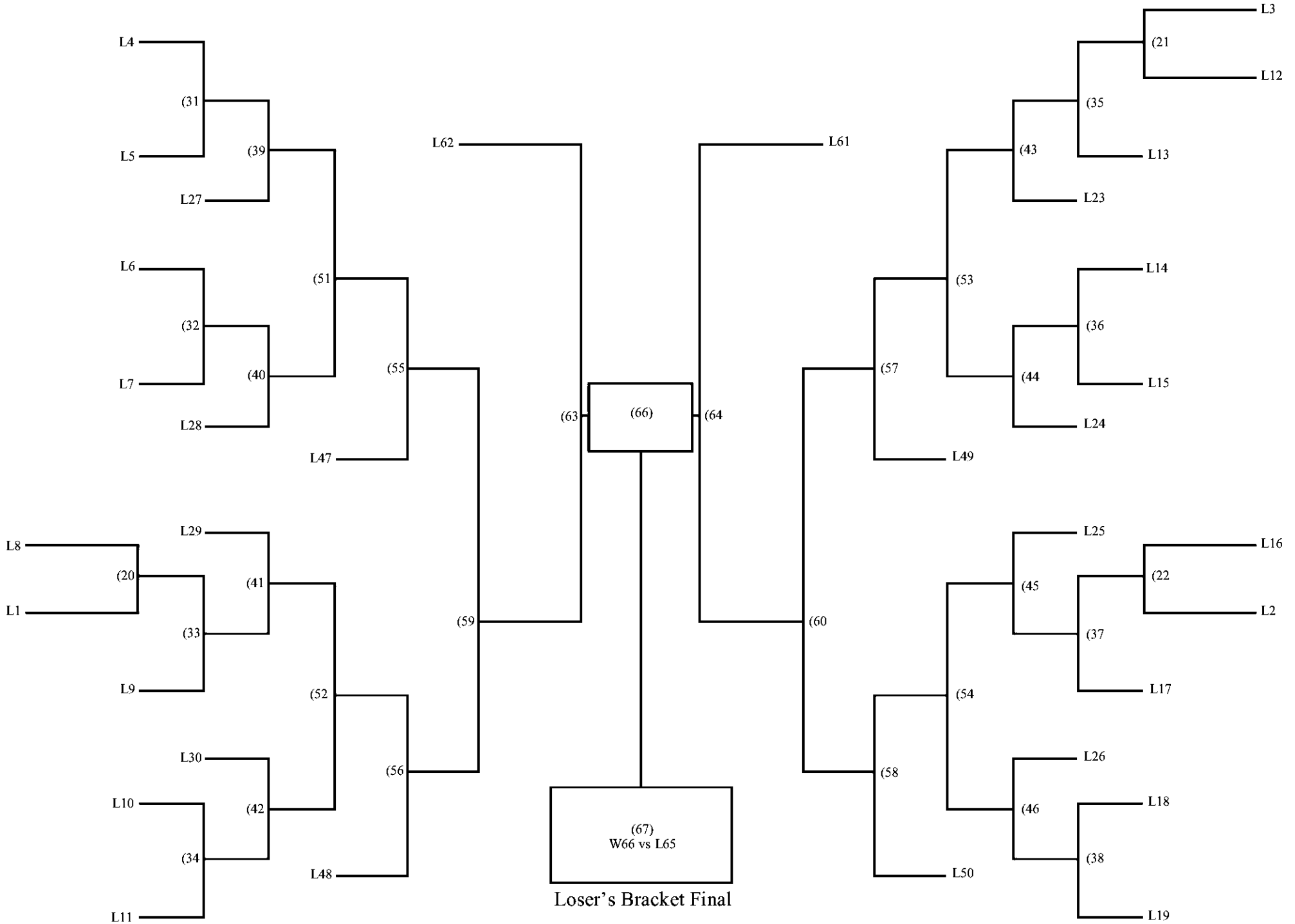

36 Person Double Elimination

Winner's Bracket



Loser's Bracket

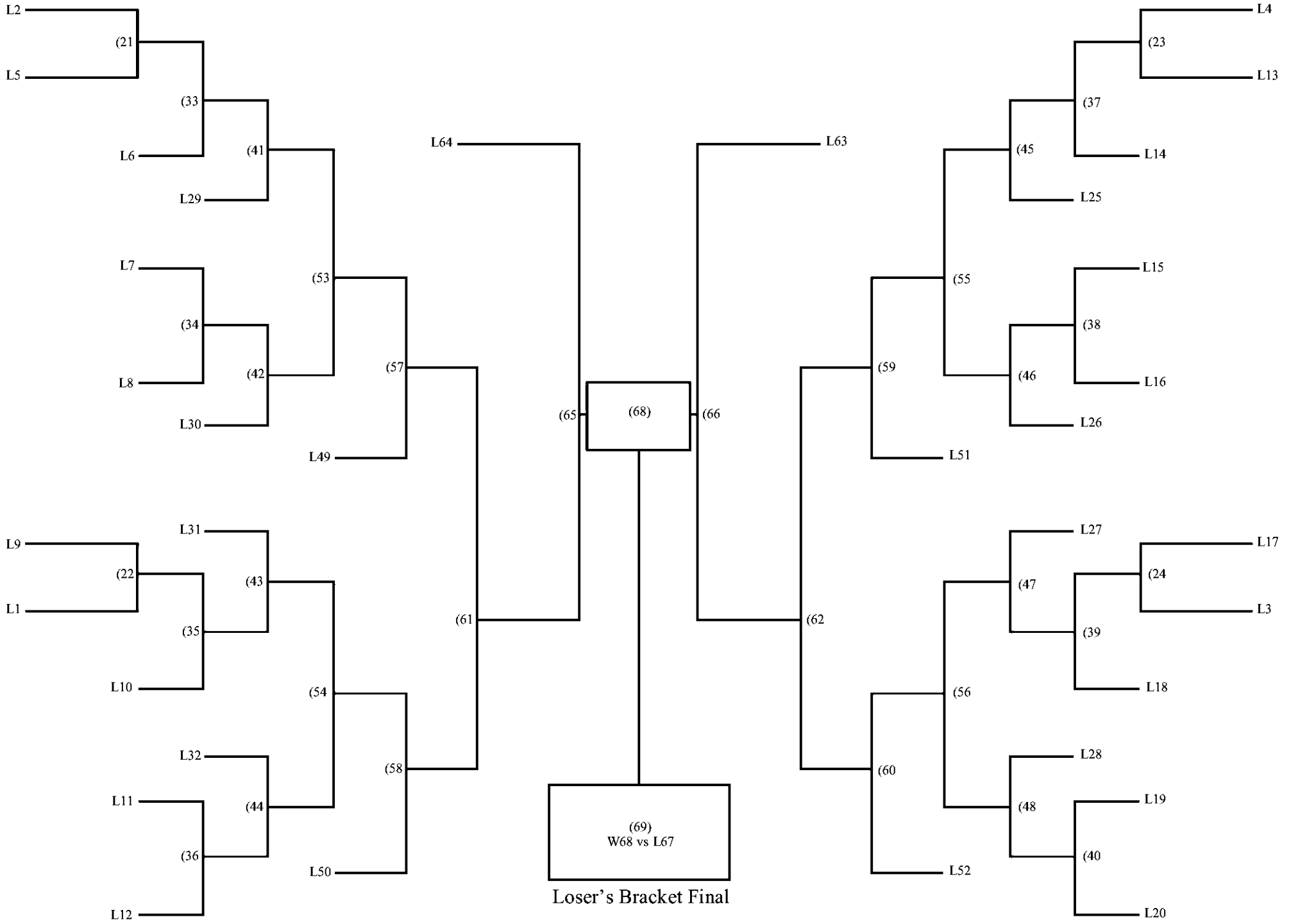

37 Person Double Elimination

Winner's Bracket

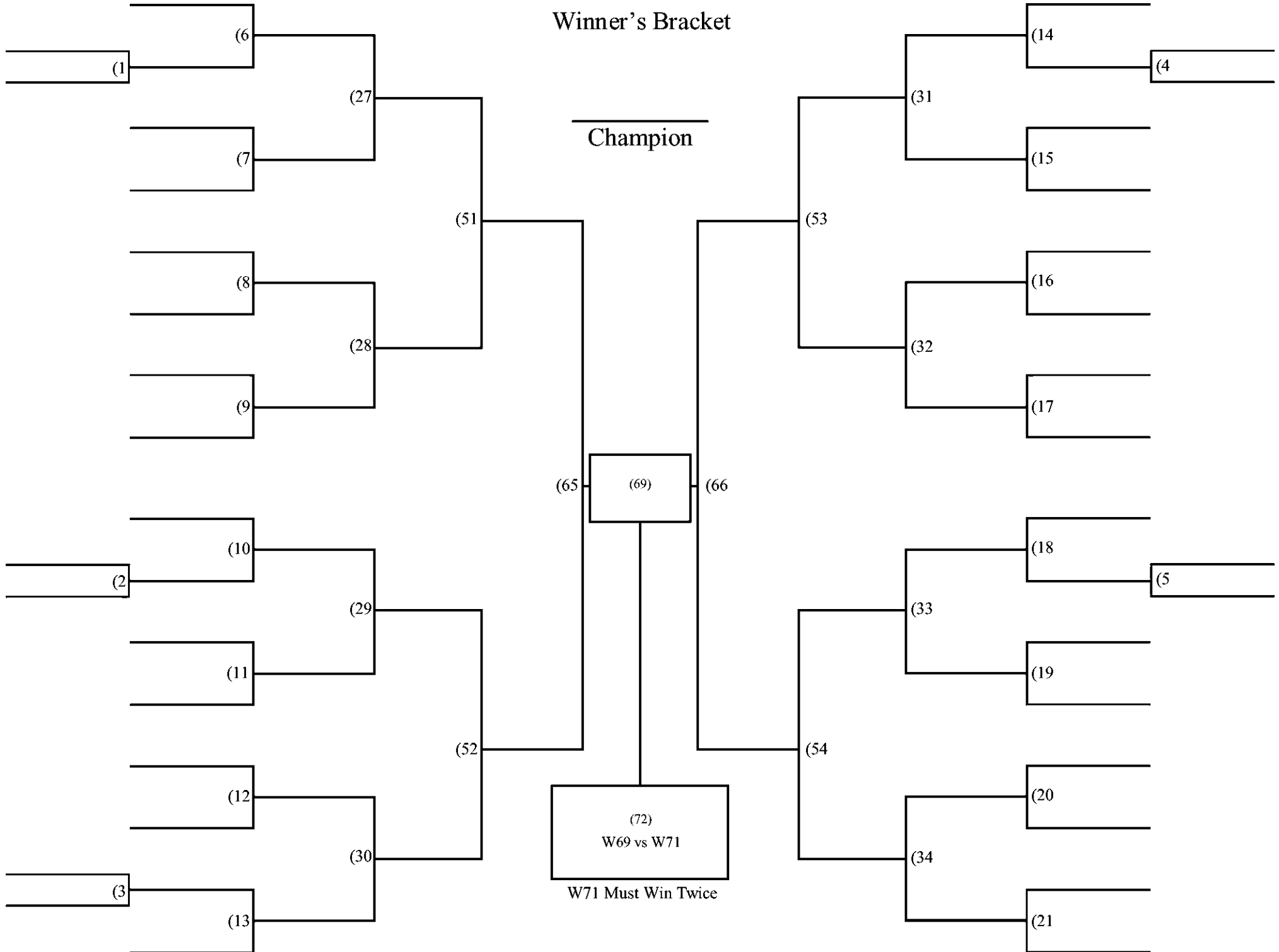

Loser's Bracket

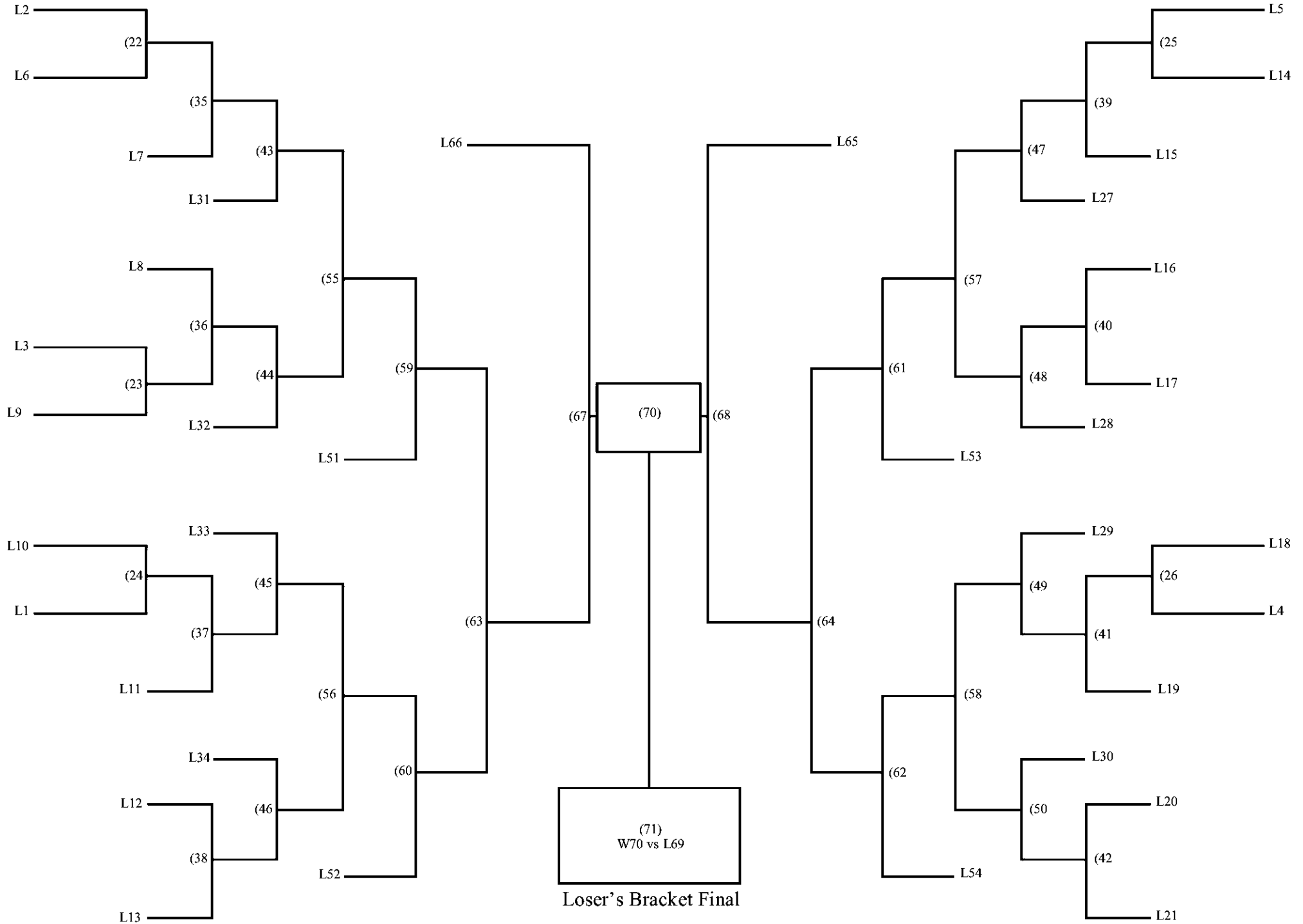

38 Person Double Elimination

Winner's Bracket

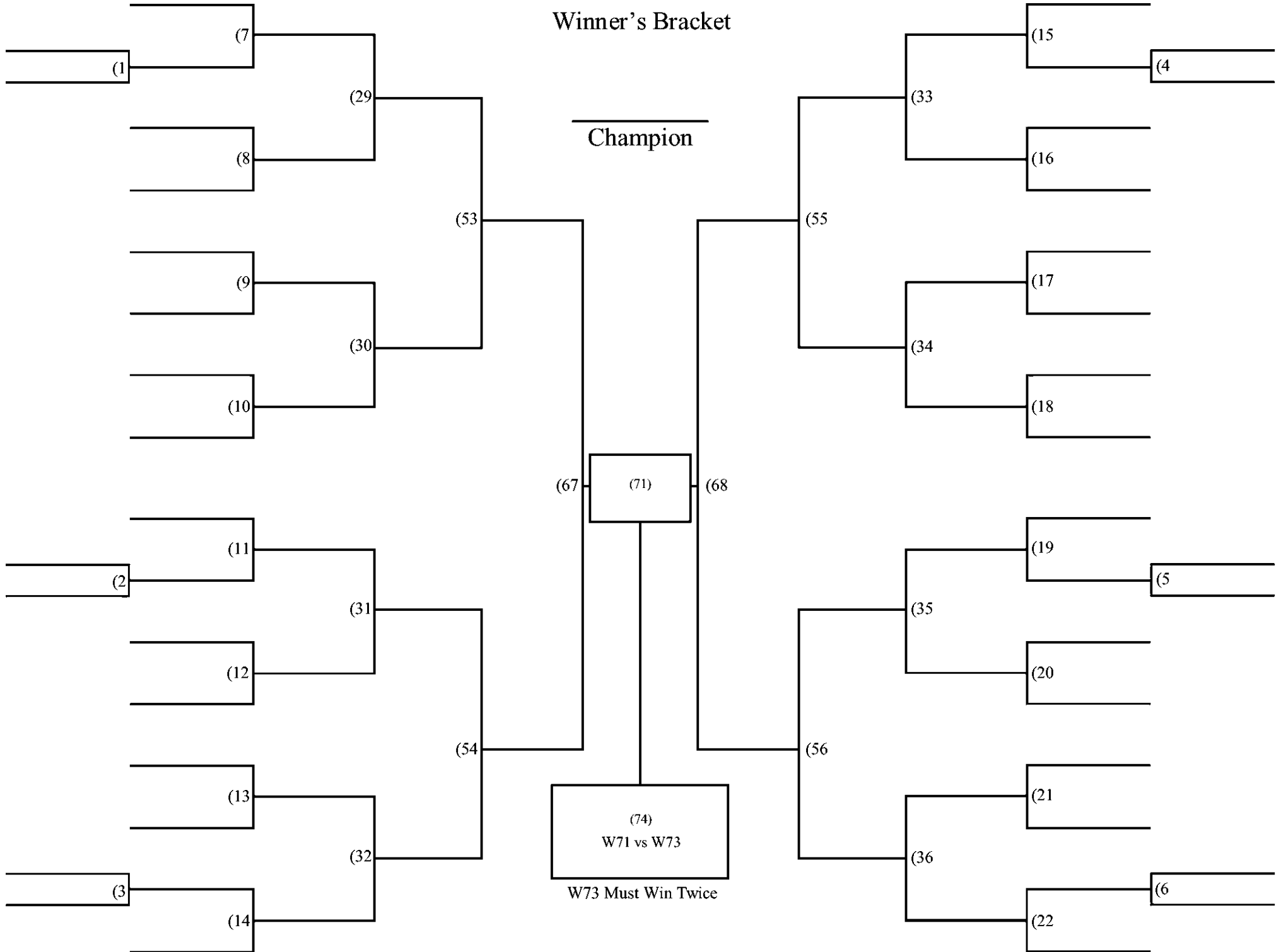

Loser's Bracket

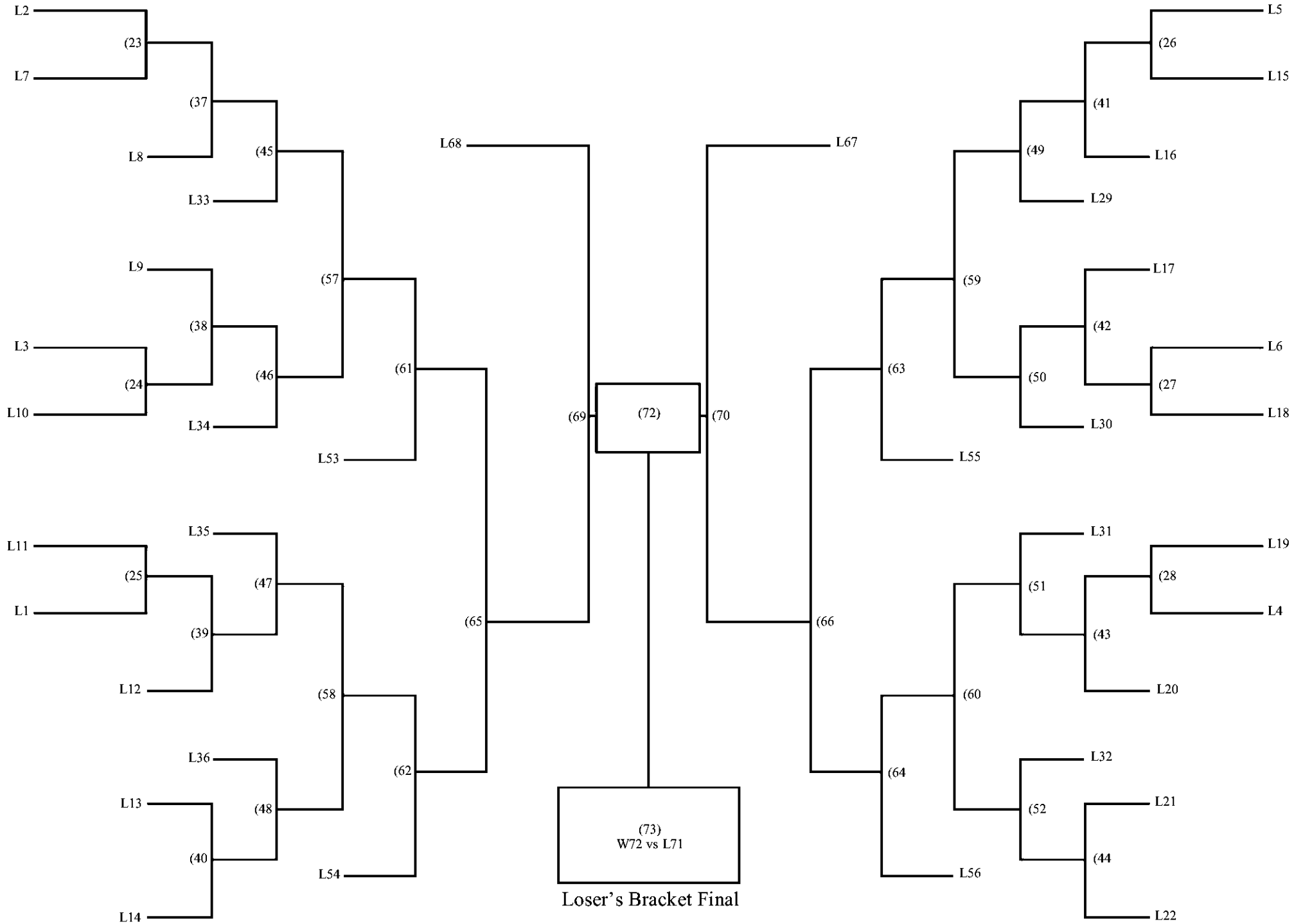

39 Person Double Elimination

Winner's Bracket

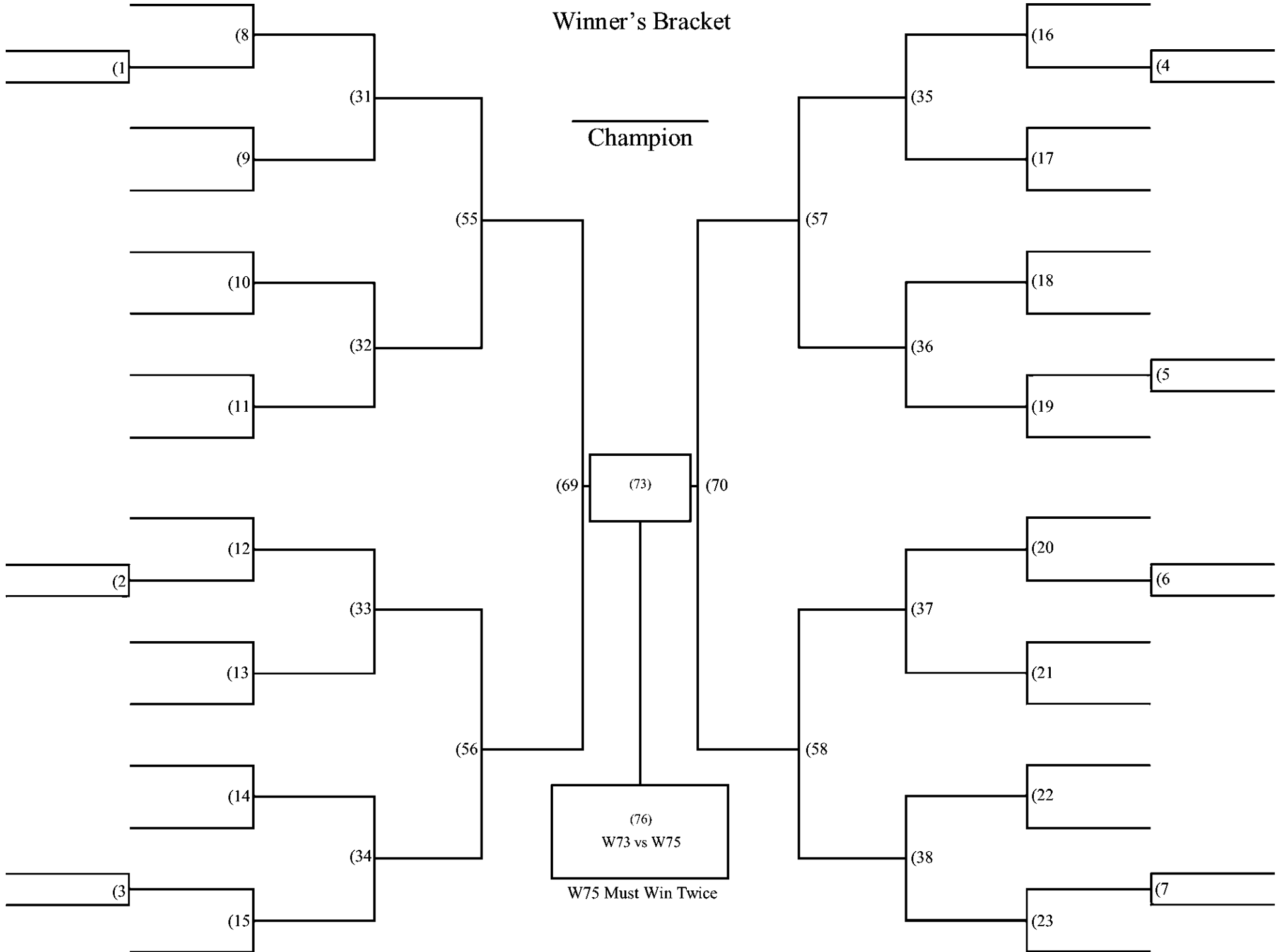

Loser's Bracket

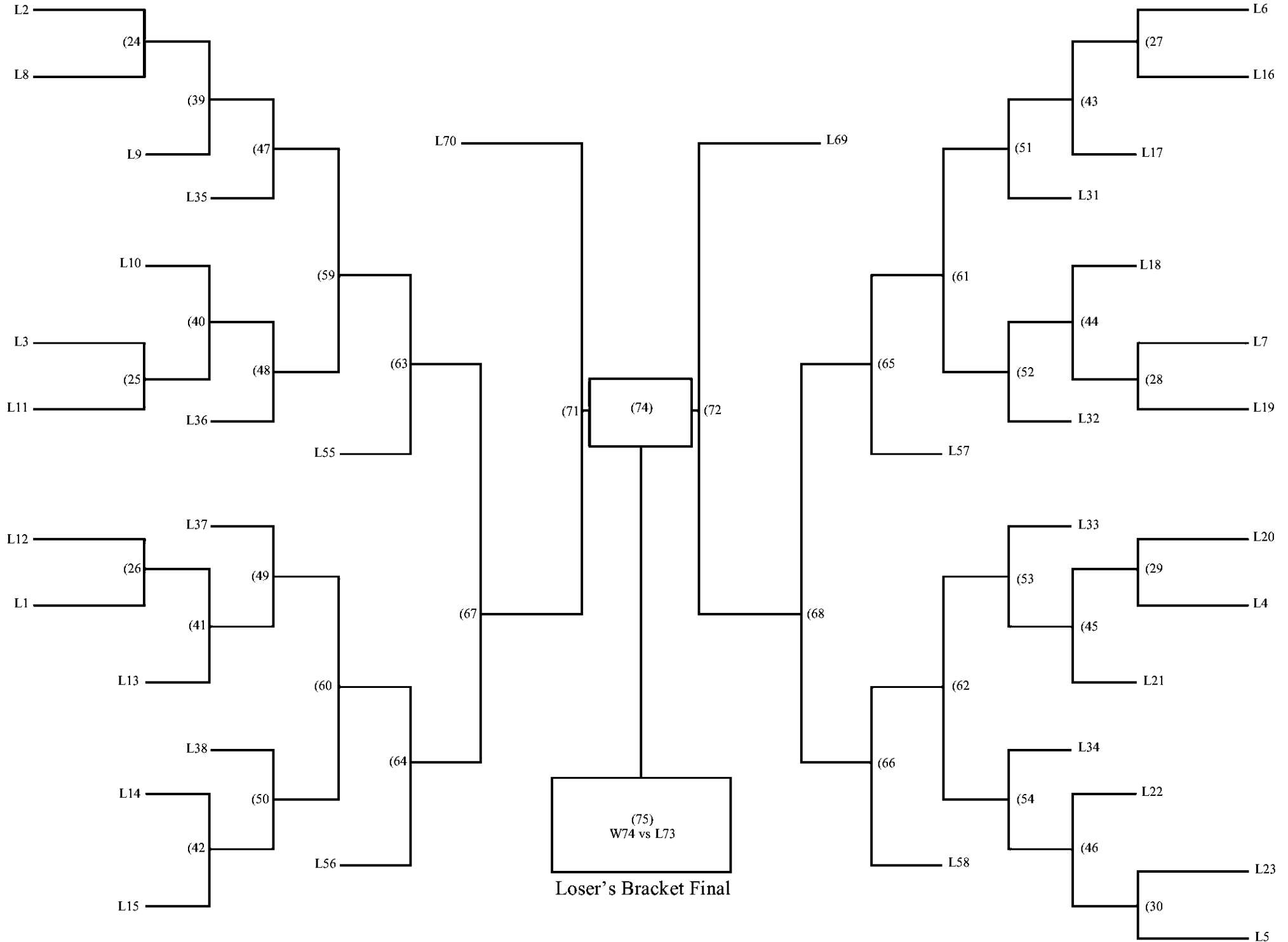

40 Person Double Elimination

Winner's Bracket

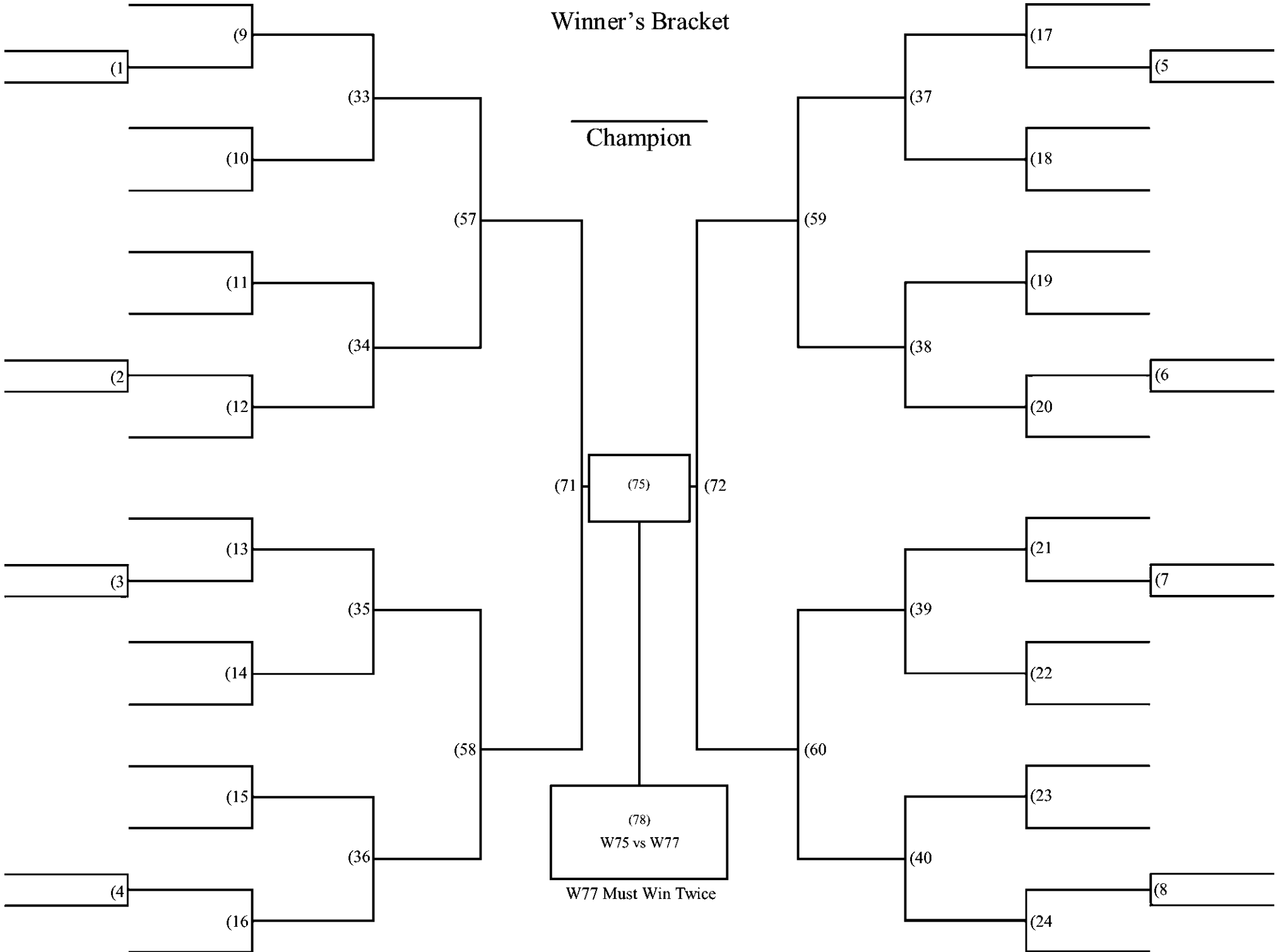

Loser's Bracket

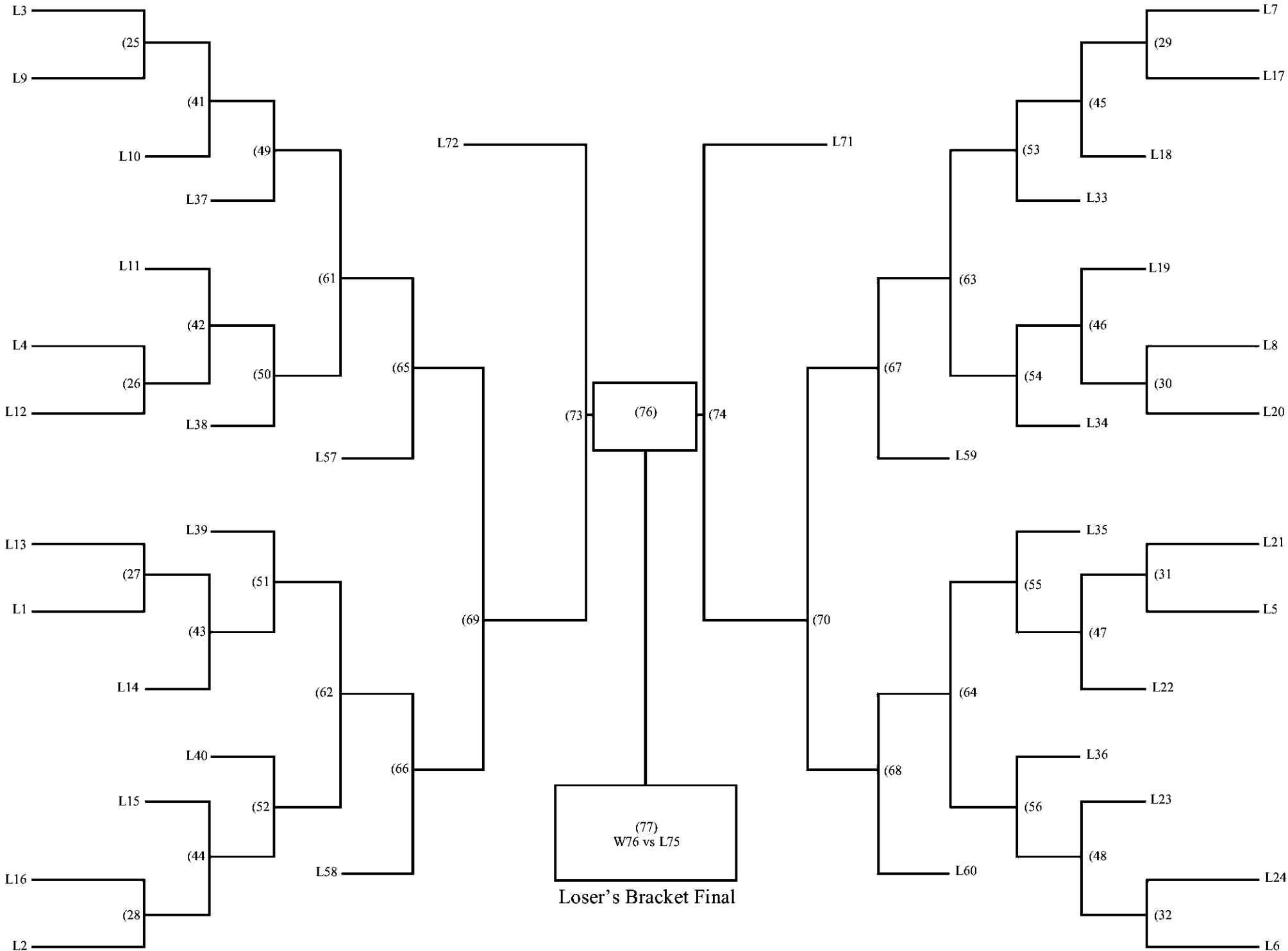

41 Person Double Elimination

Winner's Bracket

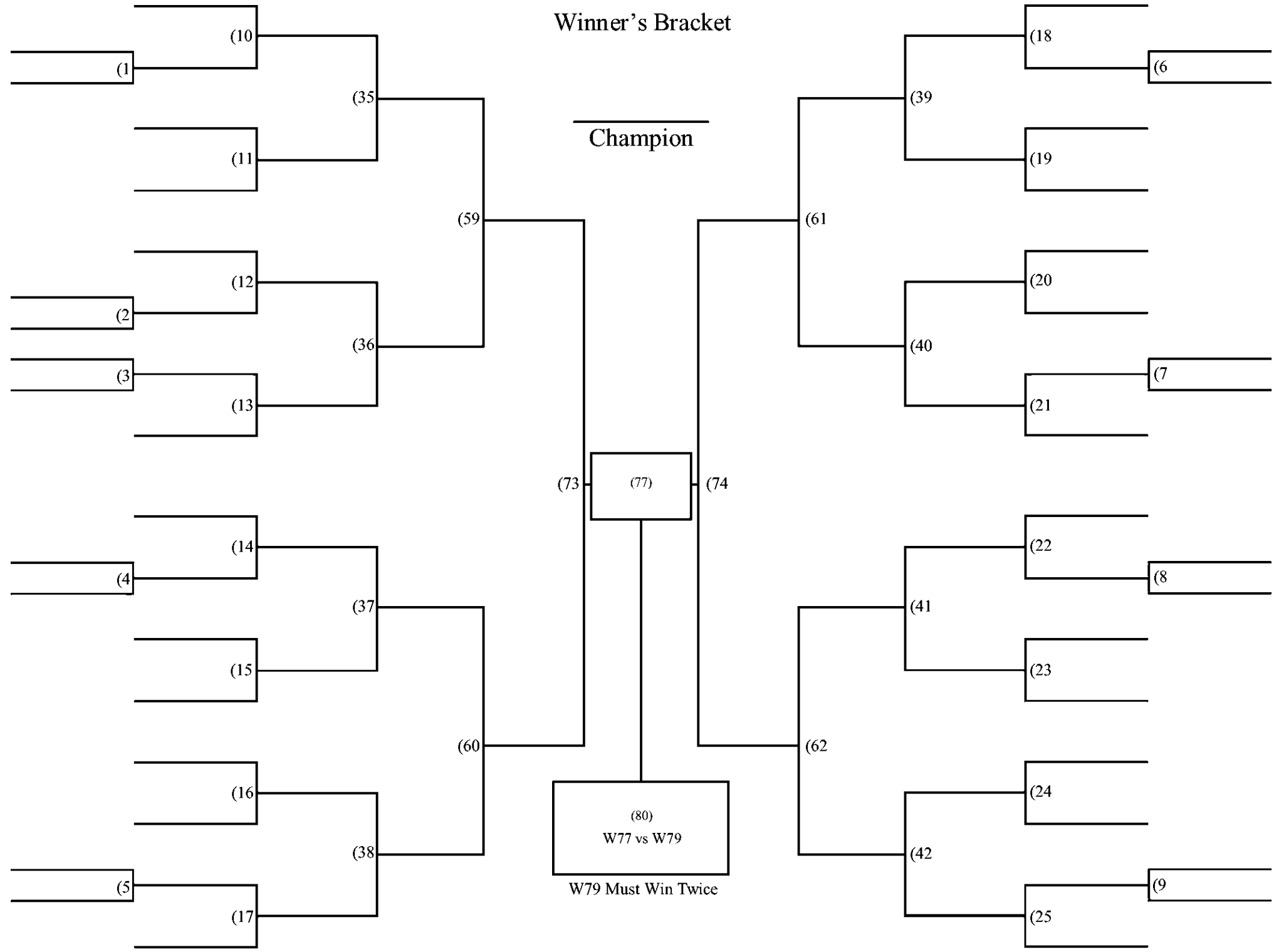

Loser's Bracket

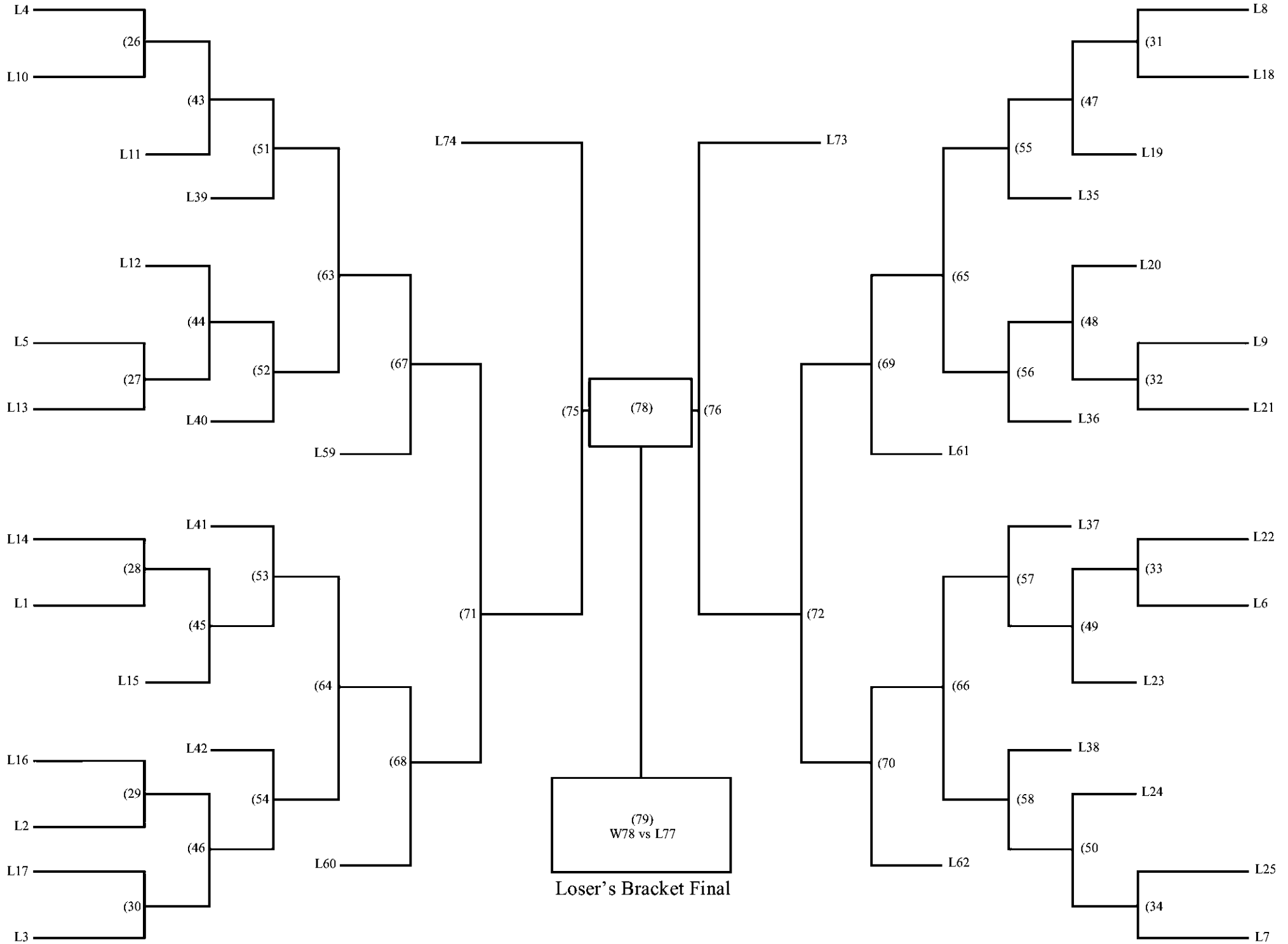

42 Person Double Elimination

Winner's Bracket

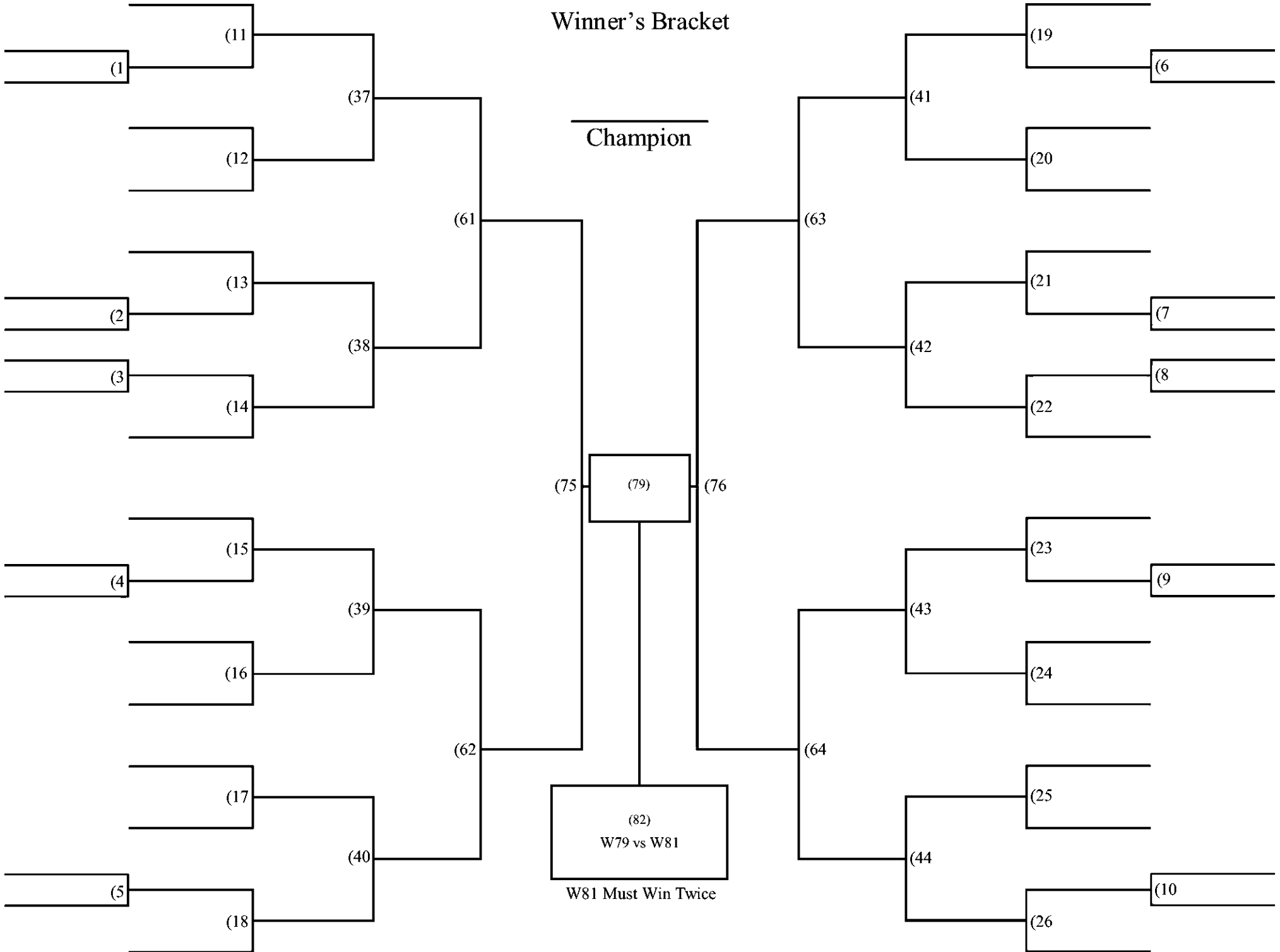

Loser's Bracket

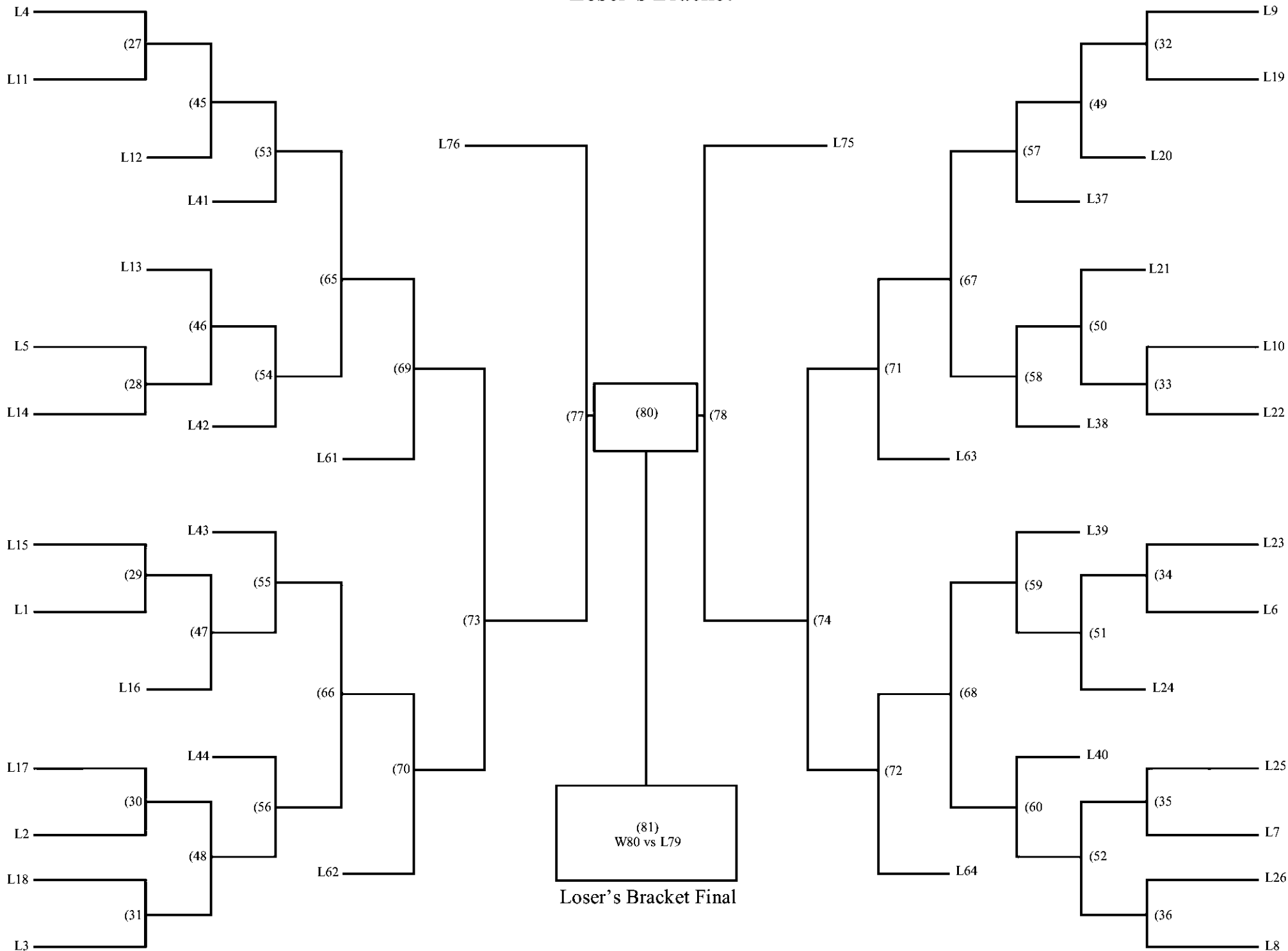

43 Person Double Elimination

Winner's Bracket

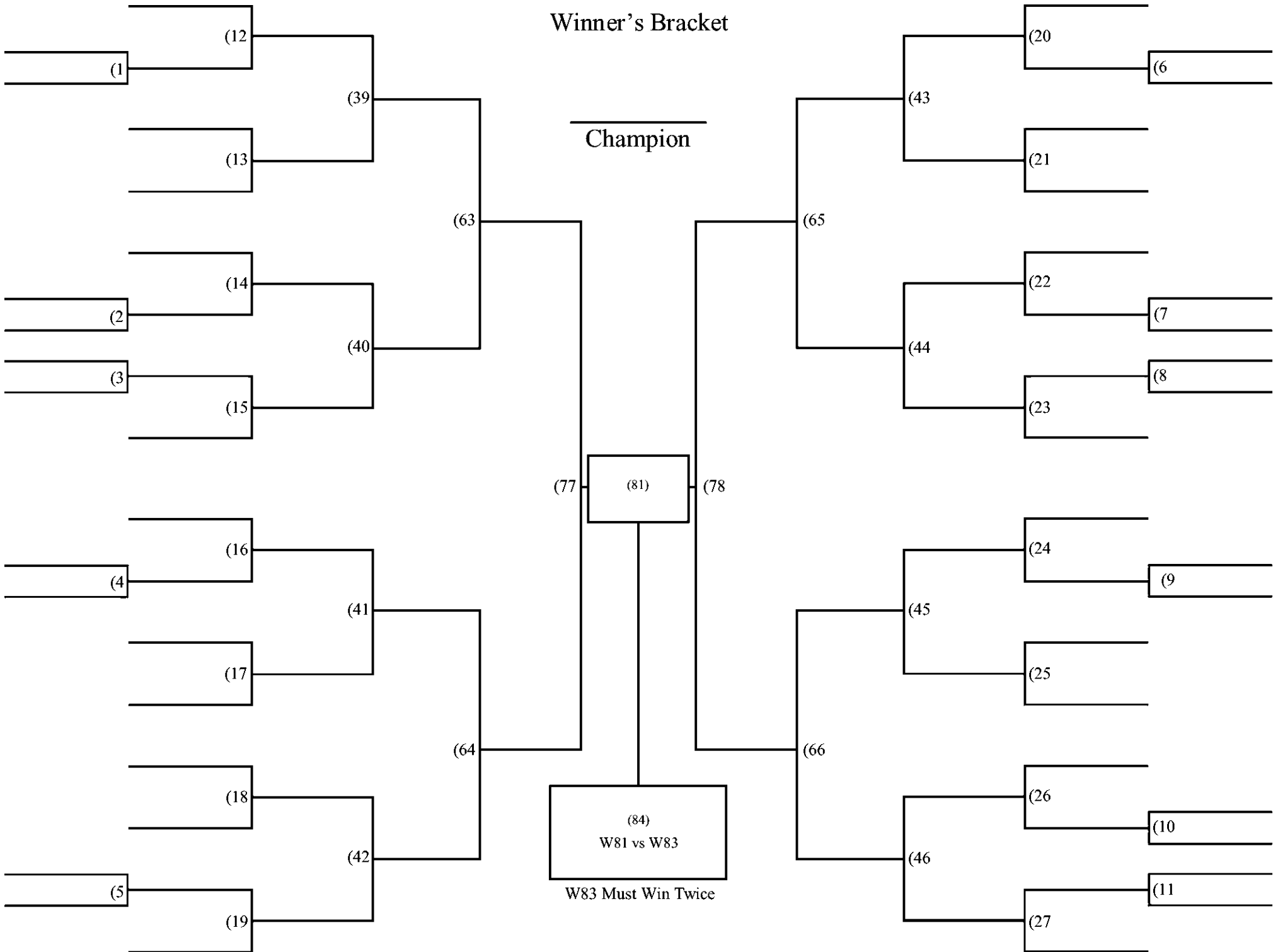

Loser's Bracket

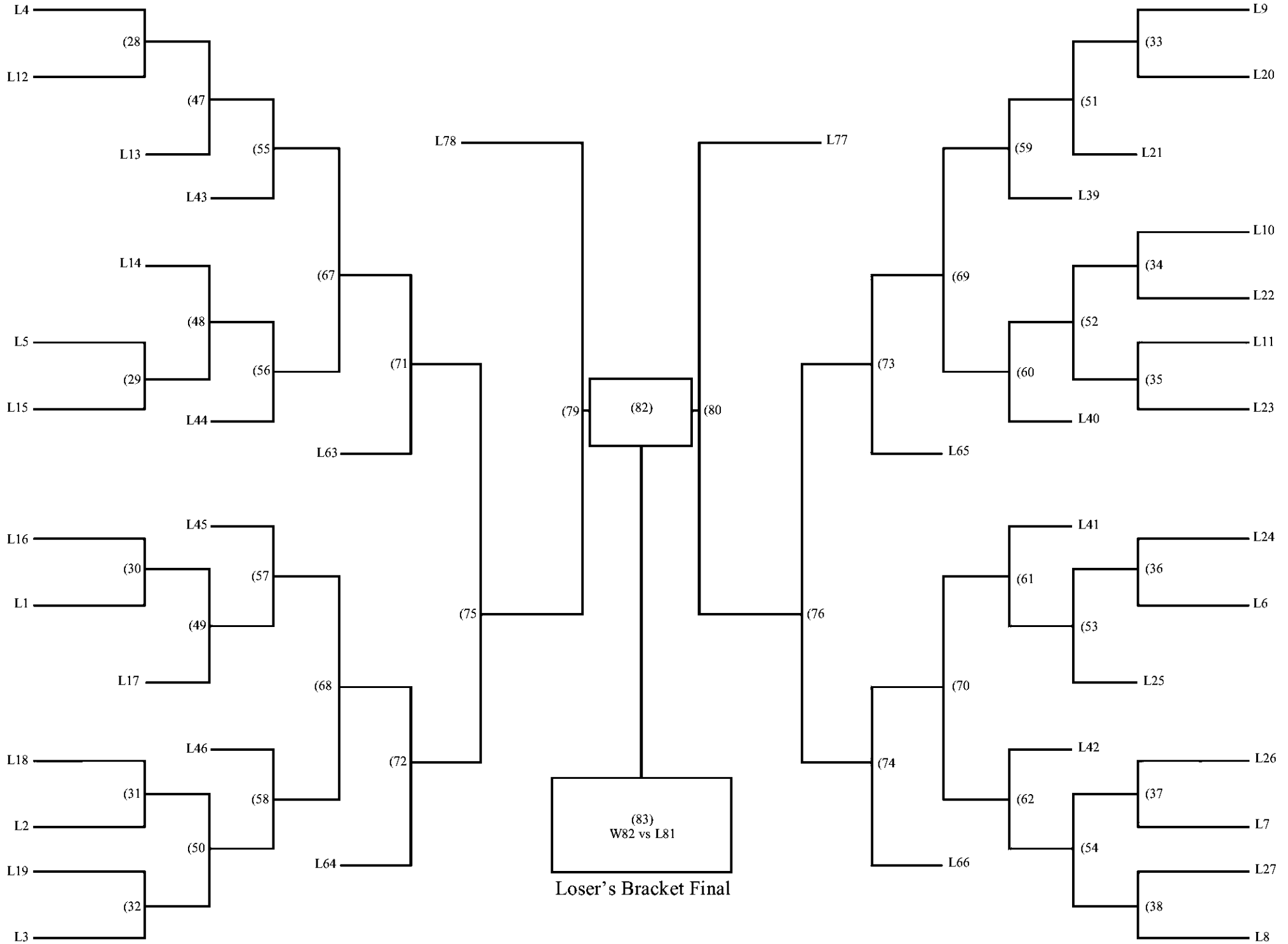

44 Person Double Elimination

Winner's Bracket

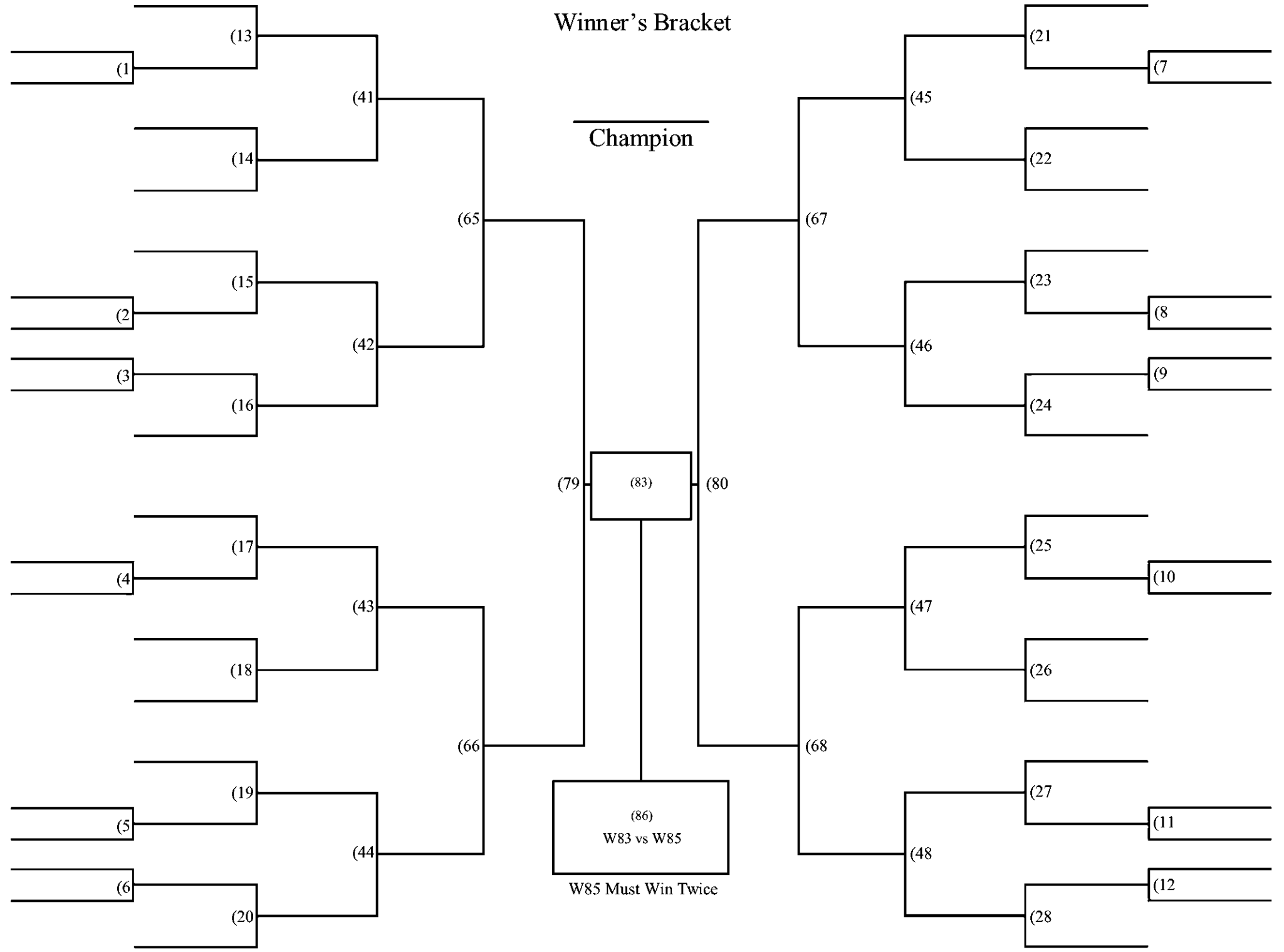

45 Person Double Elimination

Winner's Bracket

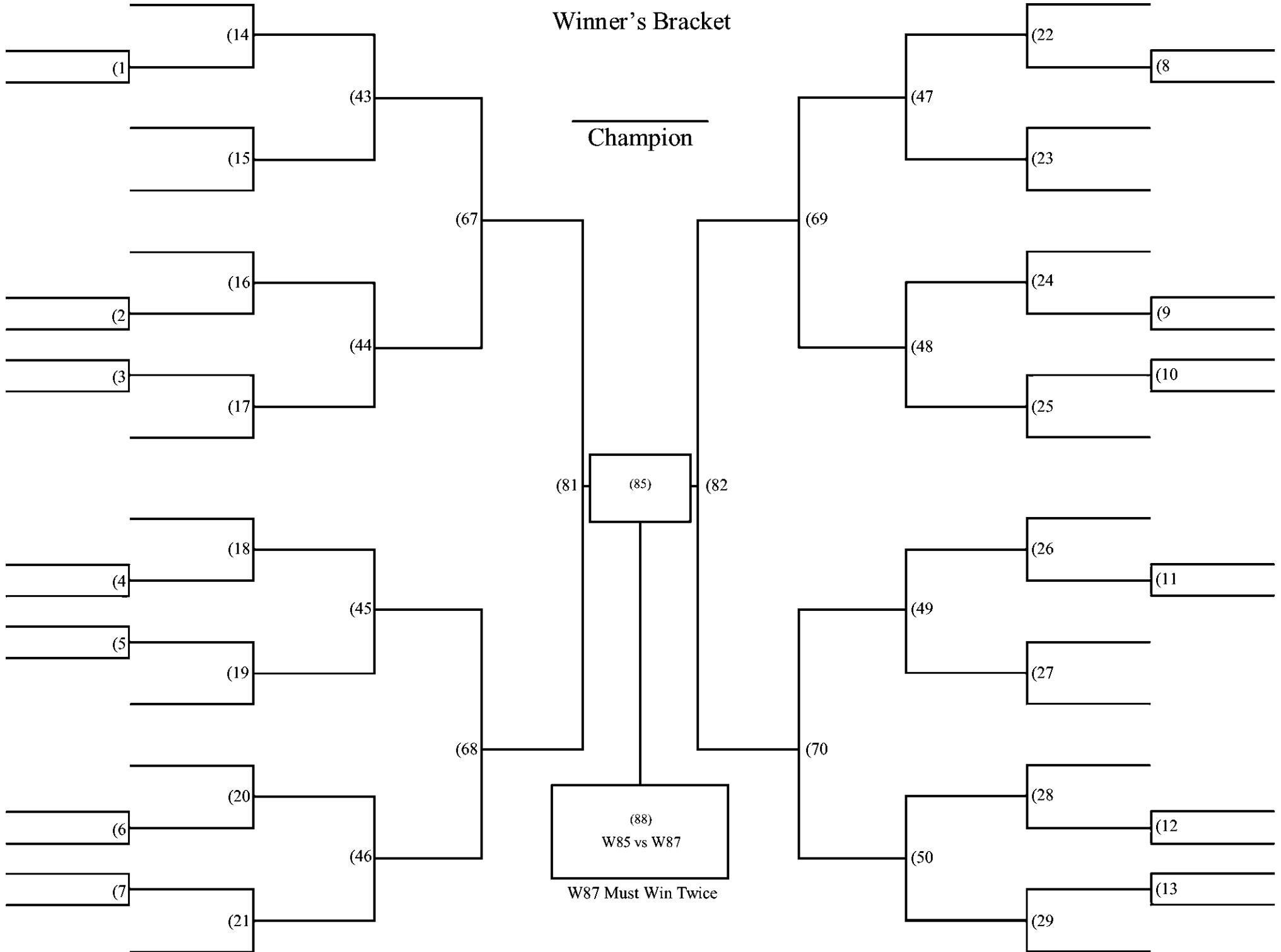

Loser's Bracket

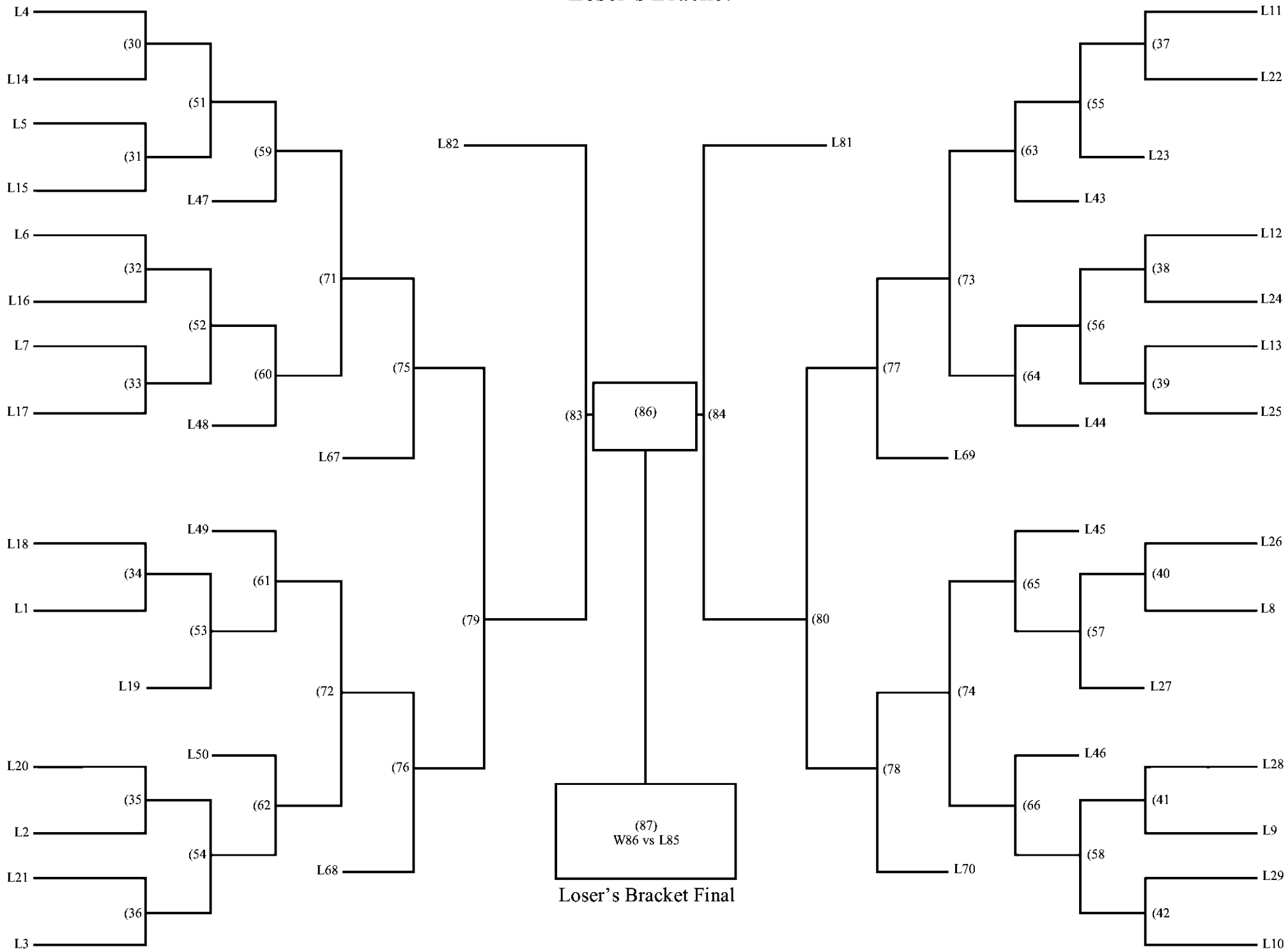

46 Person Double Elimination

Winner's Bracket

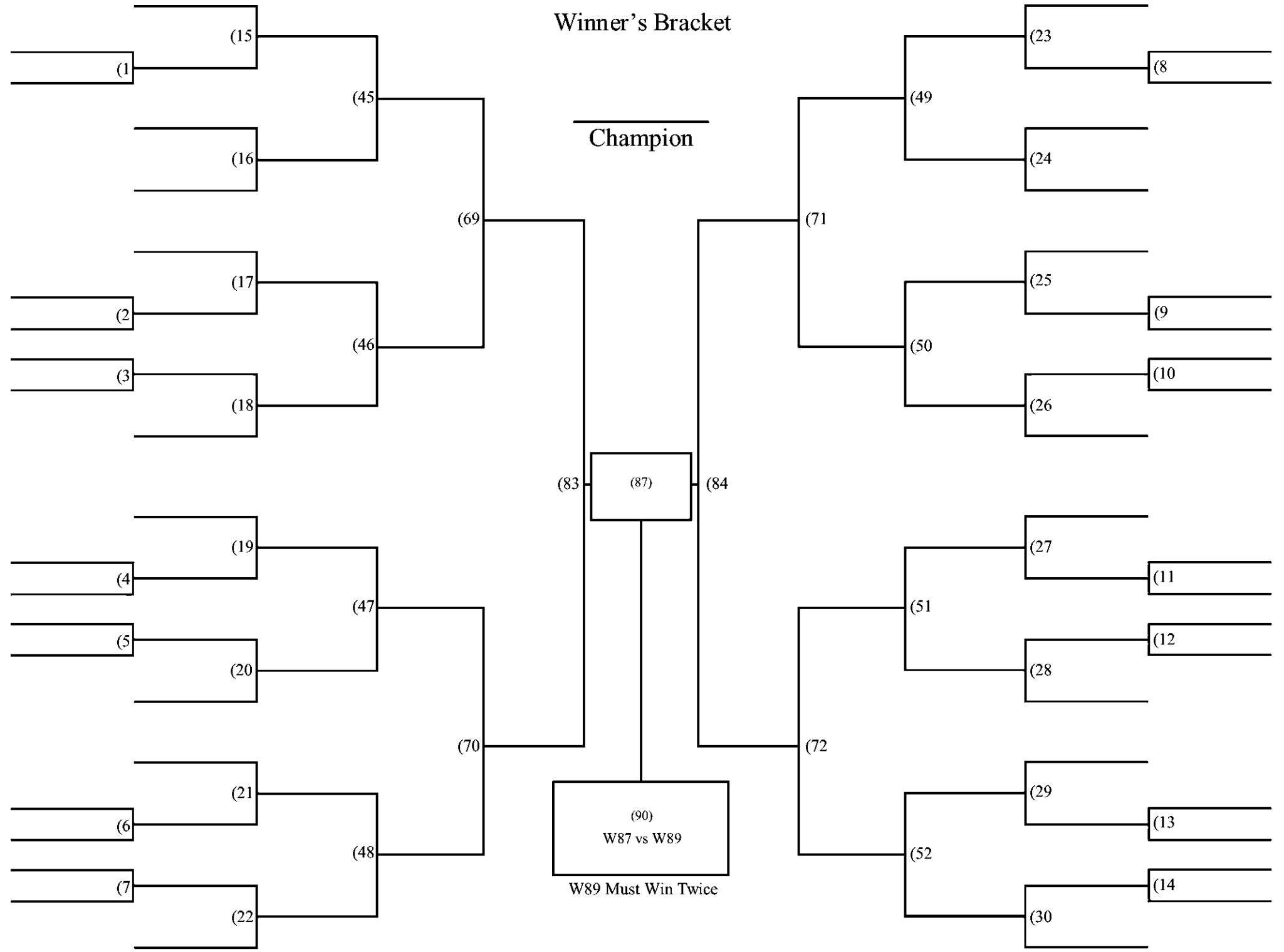

Loser's Bracket

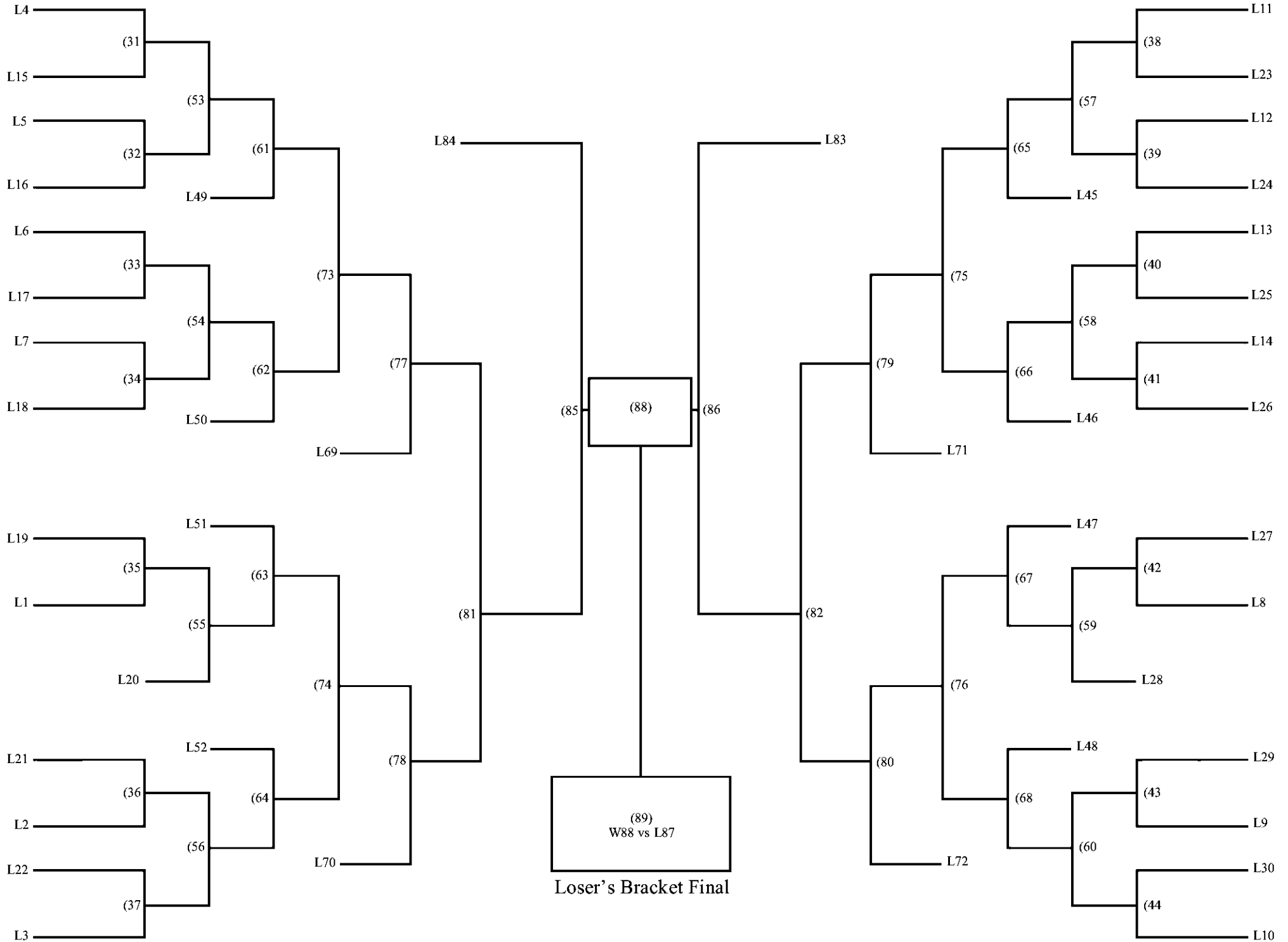

47 Person Double Elimination

Winner's Bracket

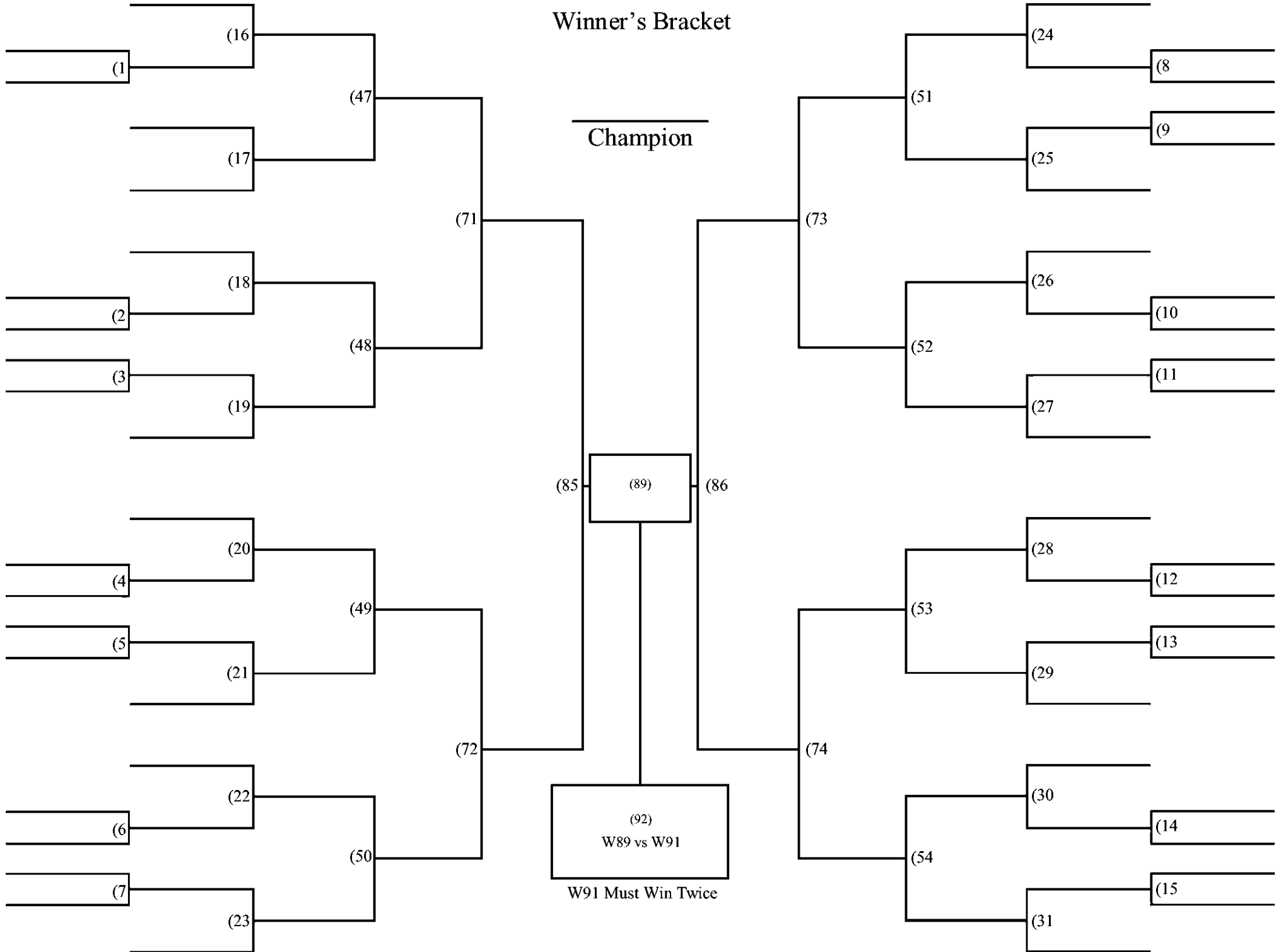

Loser's Bracket

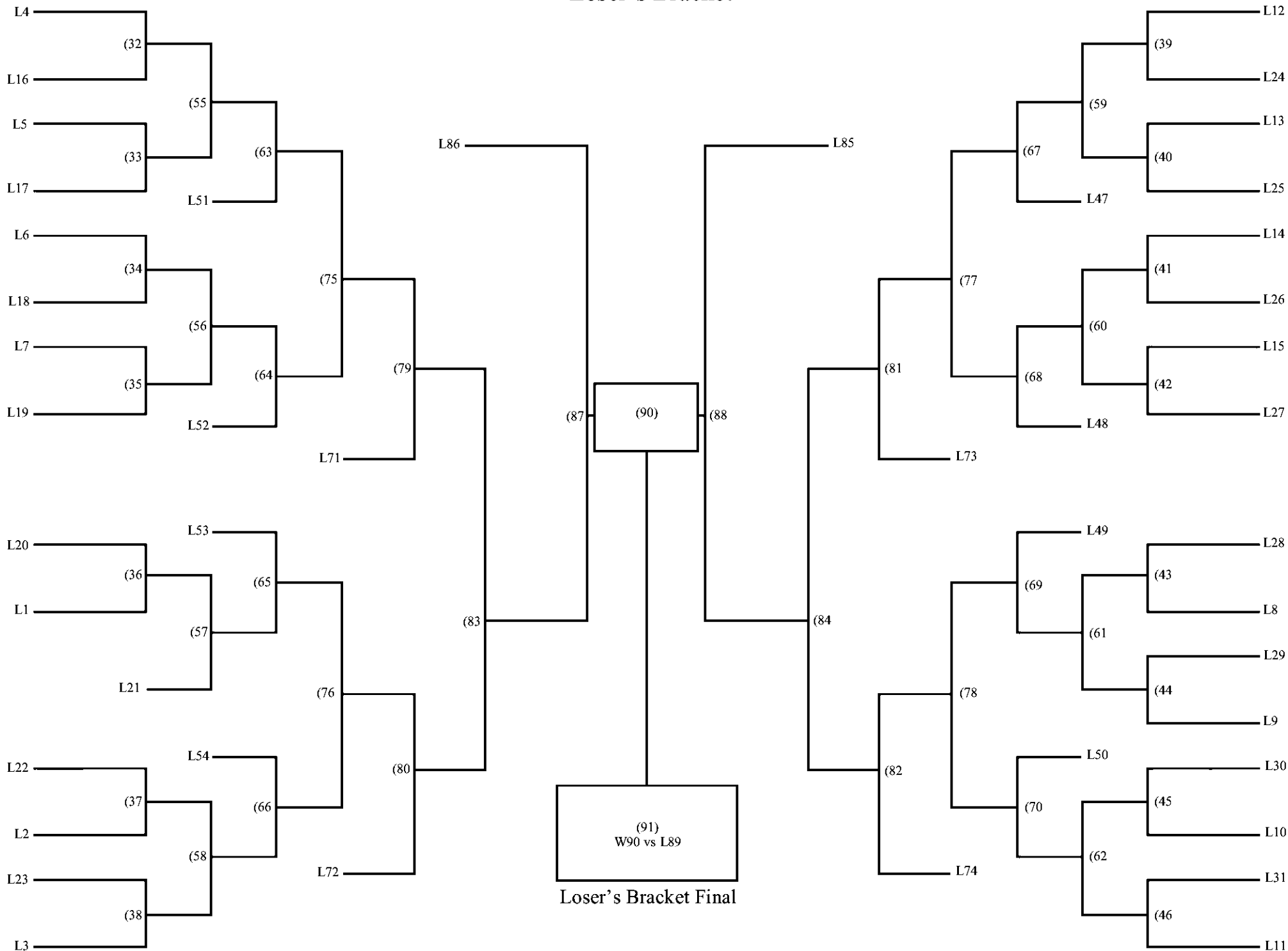

48 Person Double Elimination

Winner's Bracket

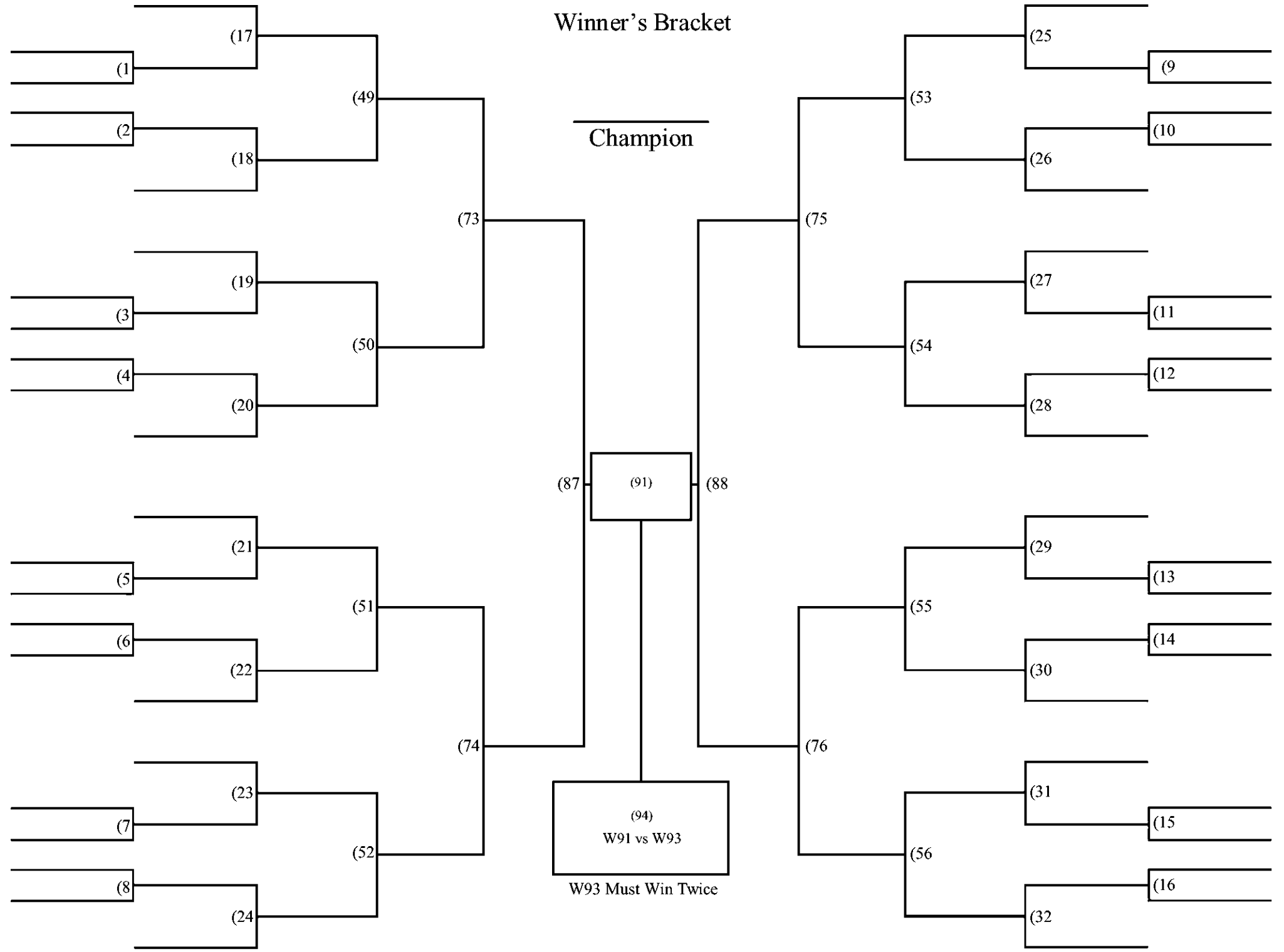

Loser's Bracket

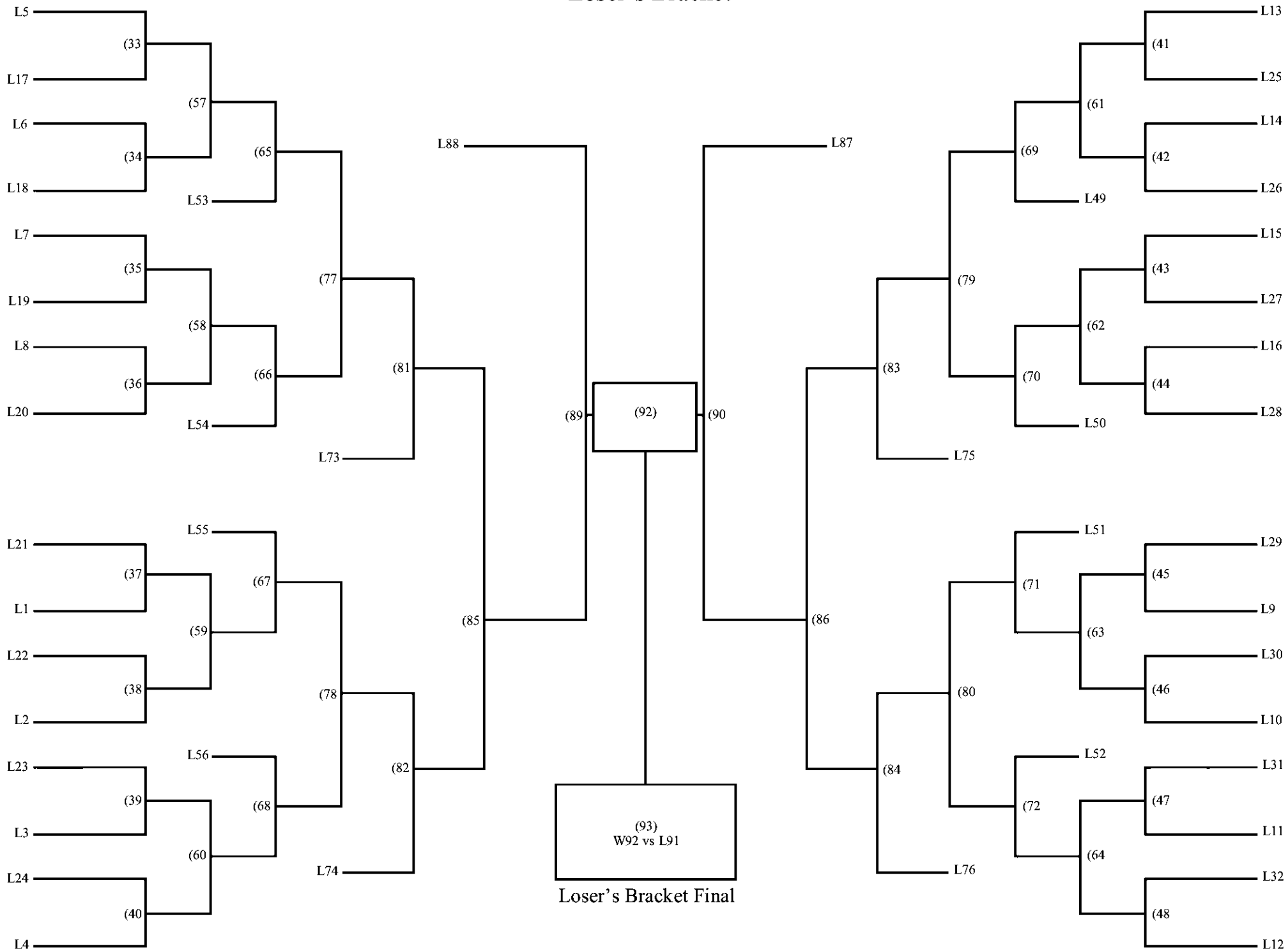

49 Person Double Elimination

Winner's Bracket

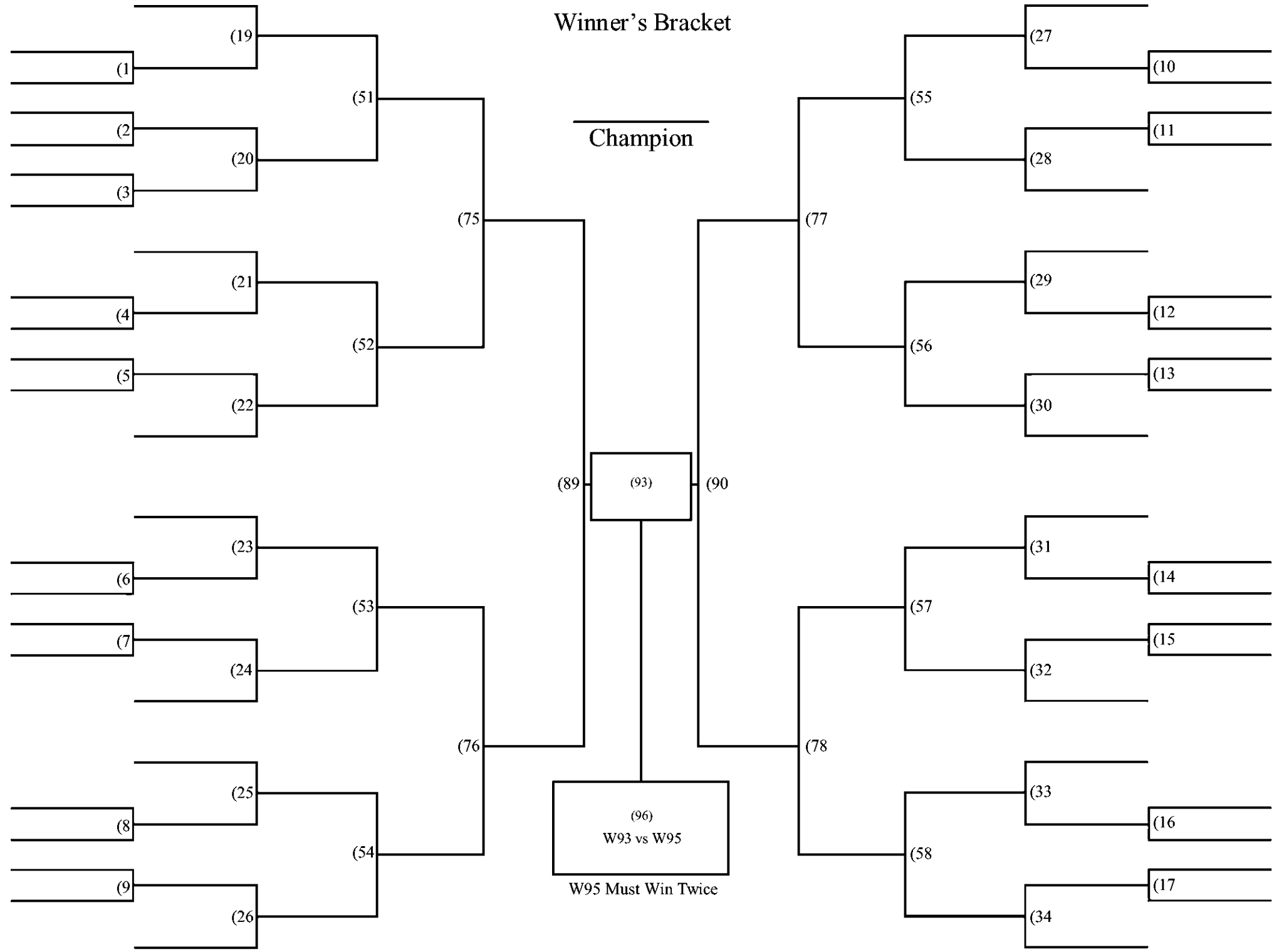

Loser's Bracket

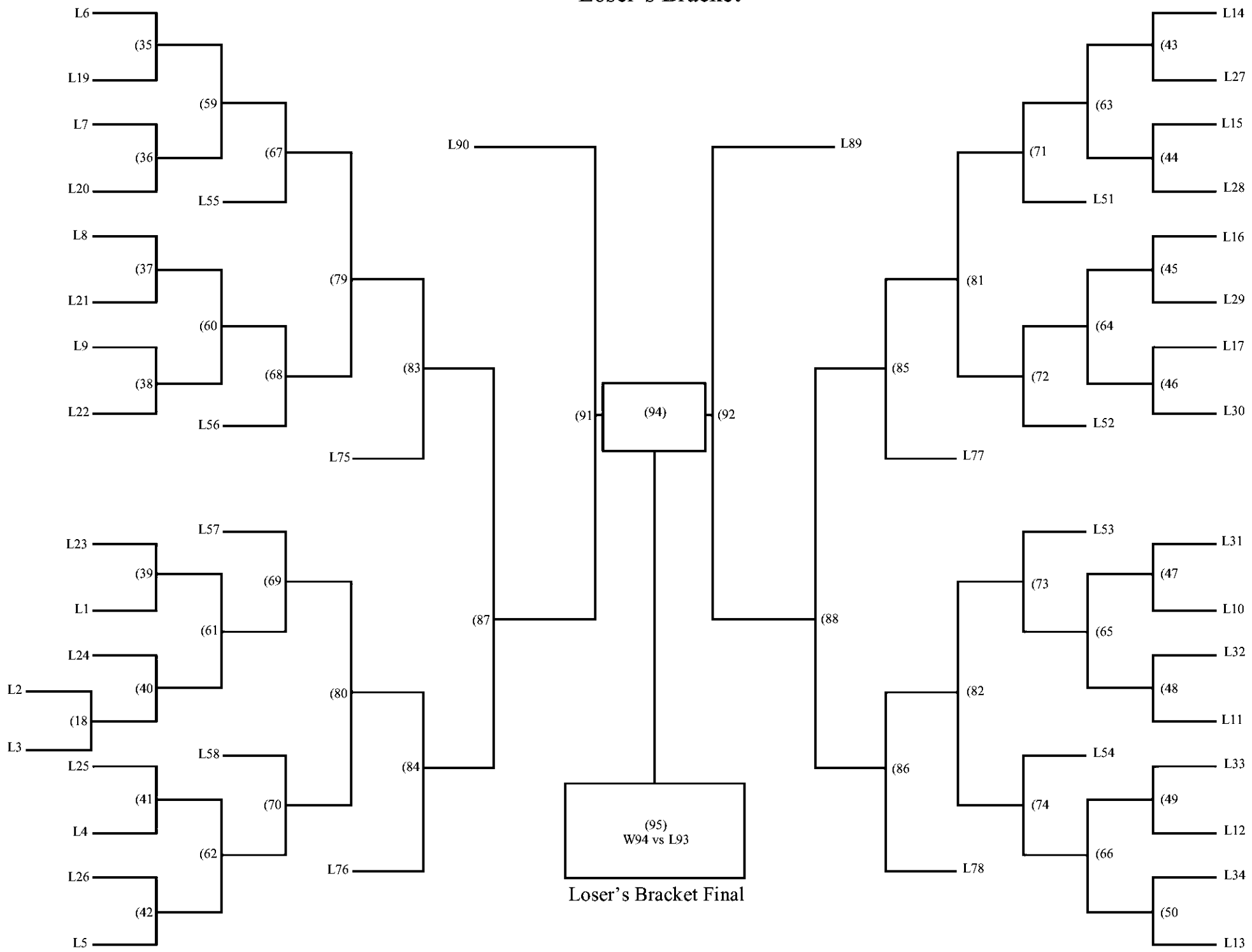

Loser's Bracket Final

50 Person Double Elimination

Winner's Bracket

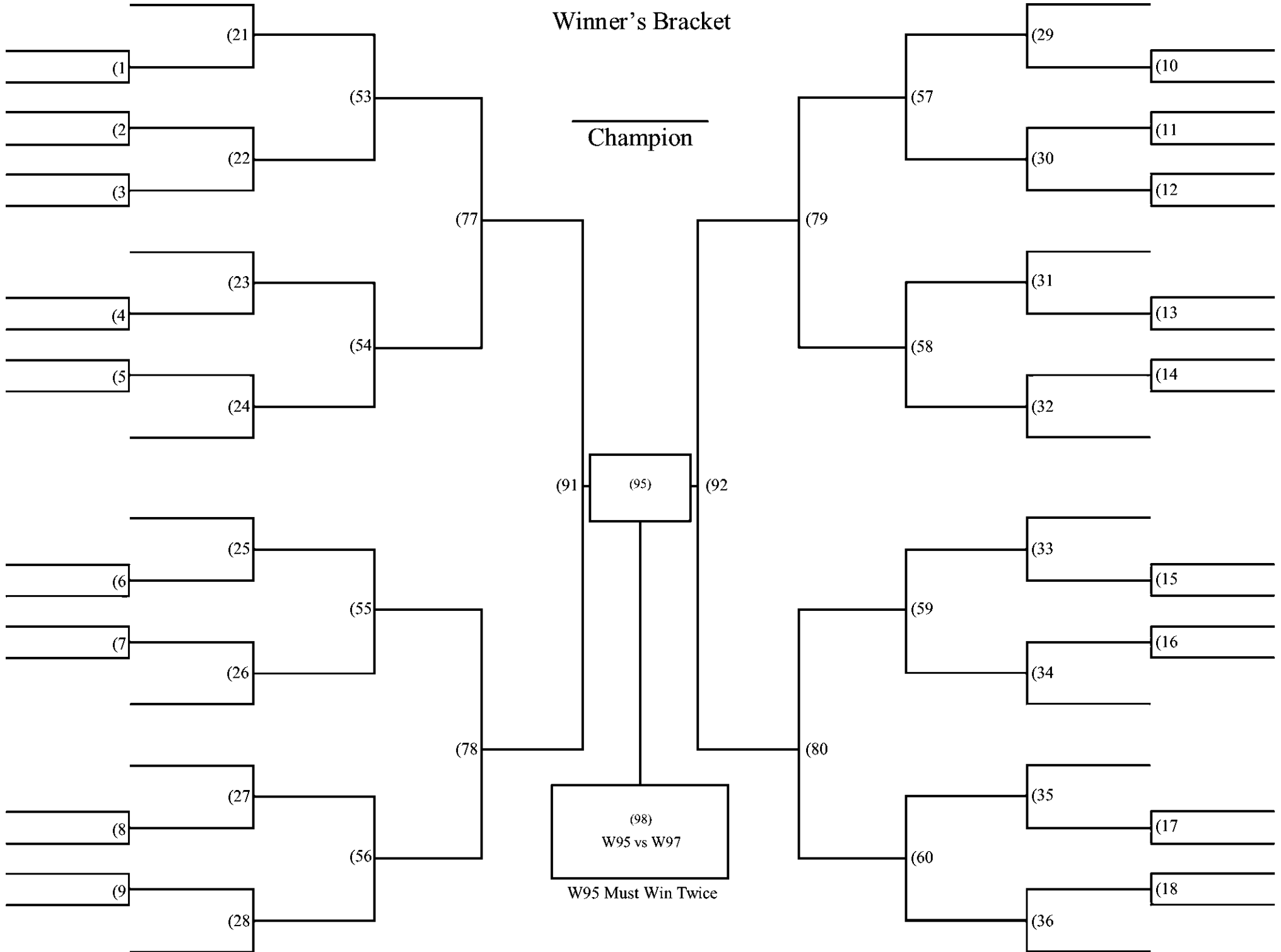

Loser's Bracket

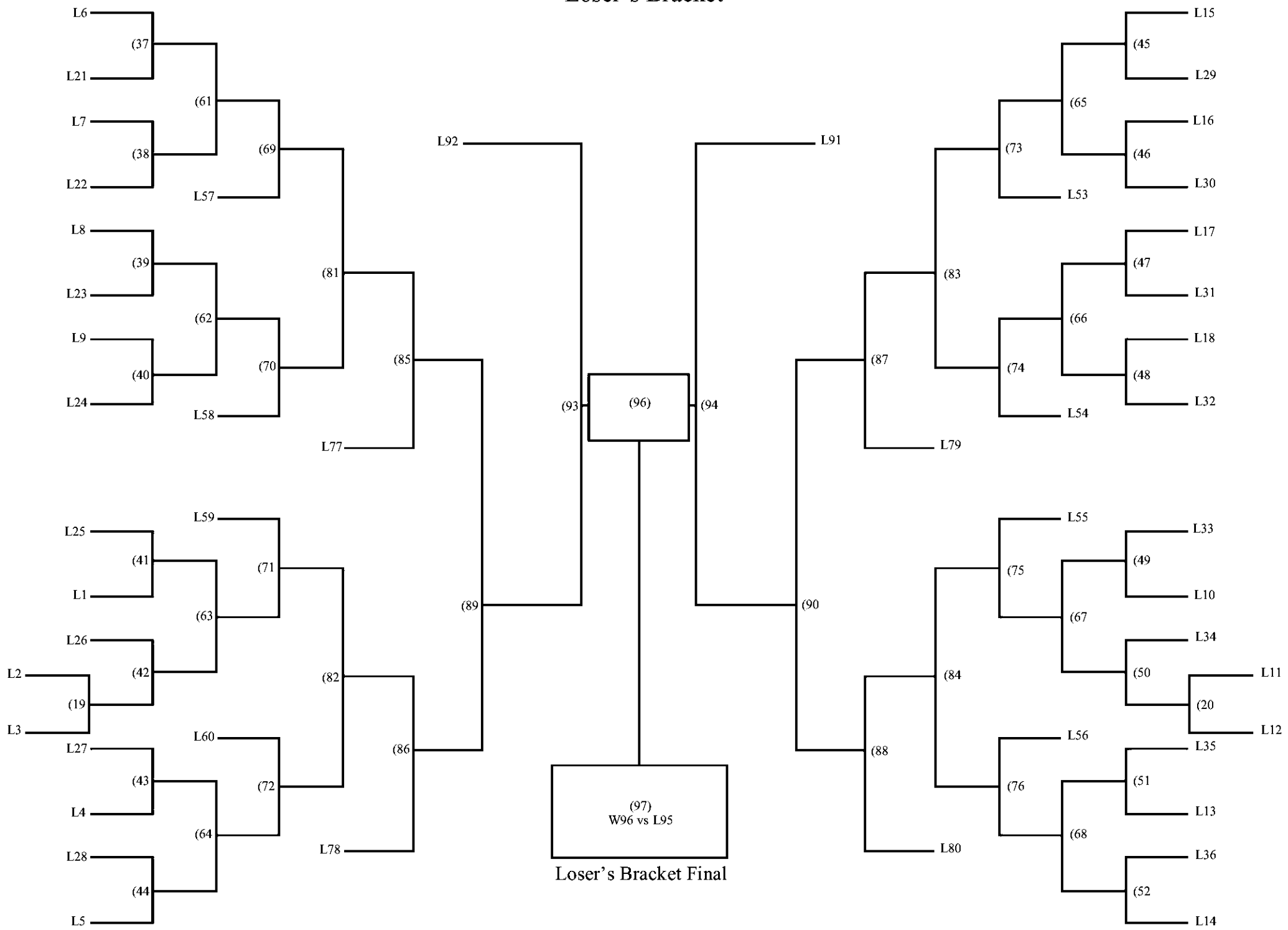

51 Person Double Elimination

Winner's Bracket

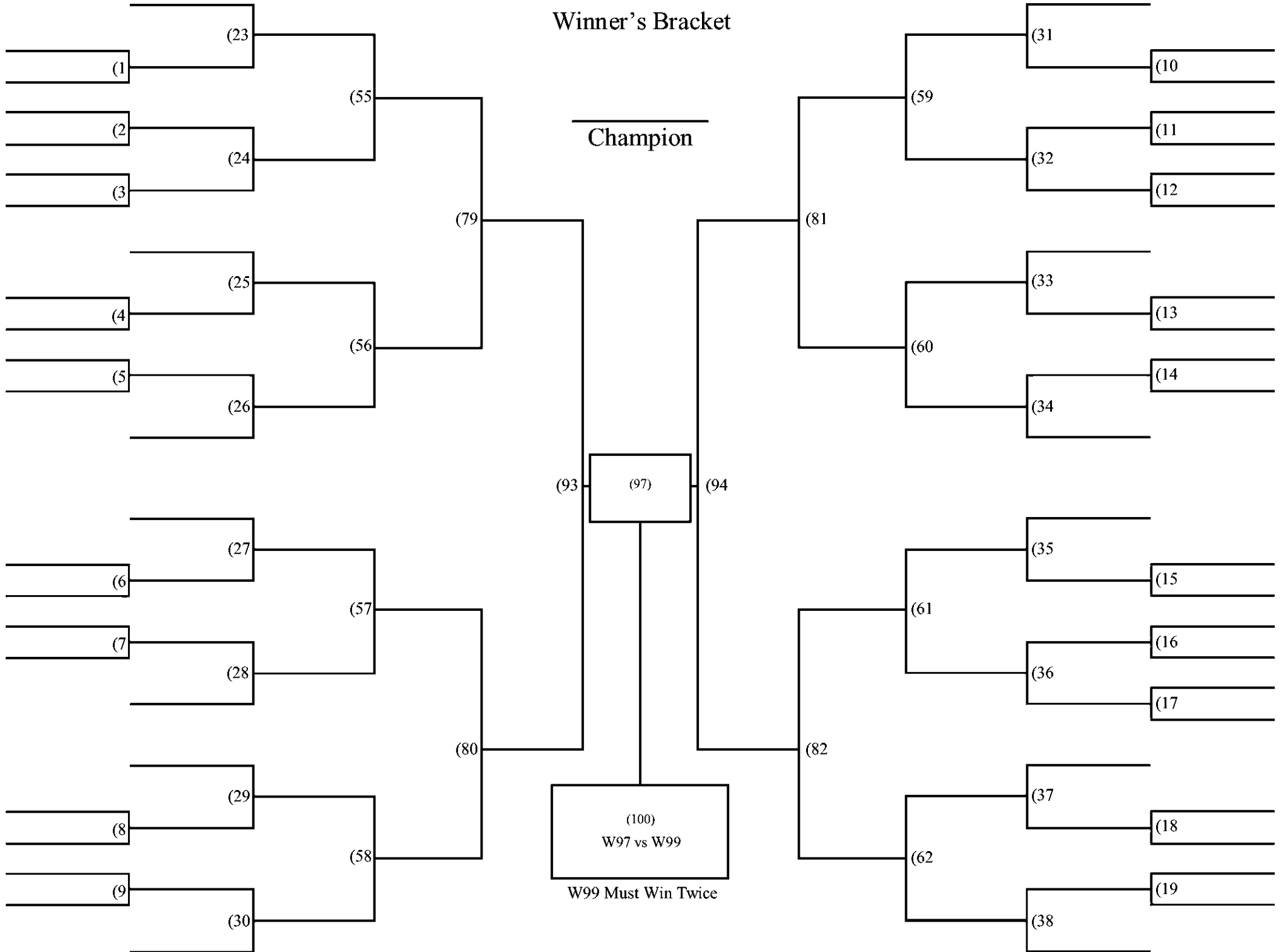

Loser's Bracket

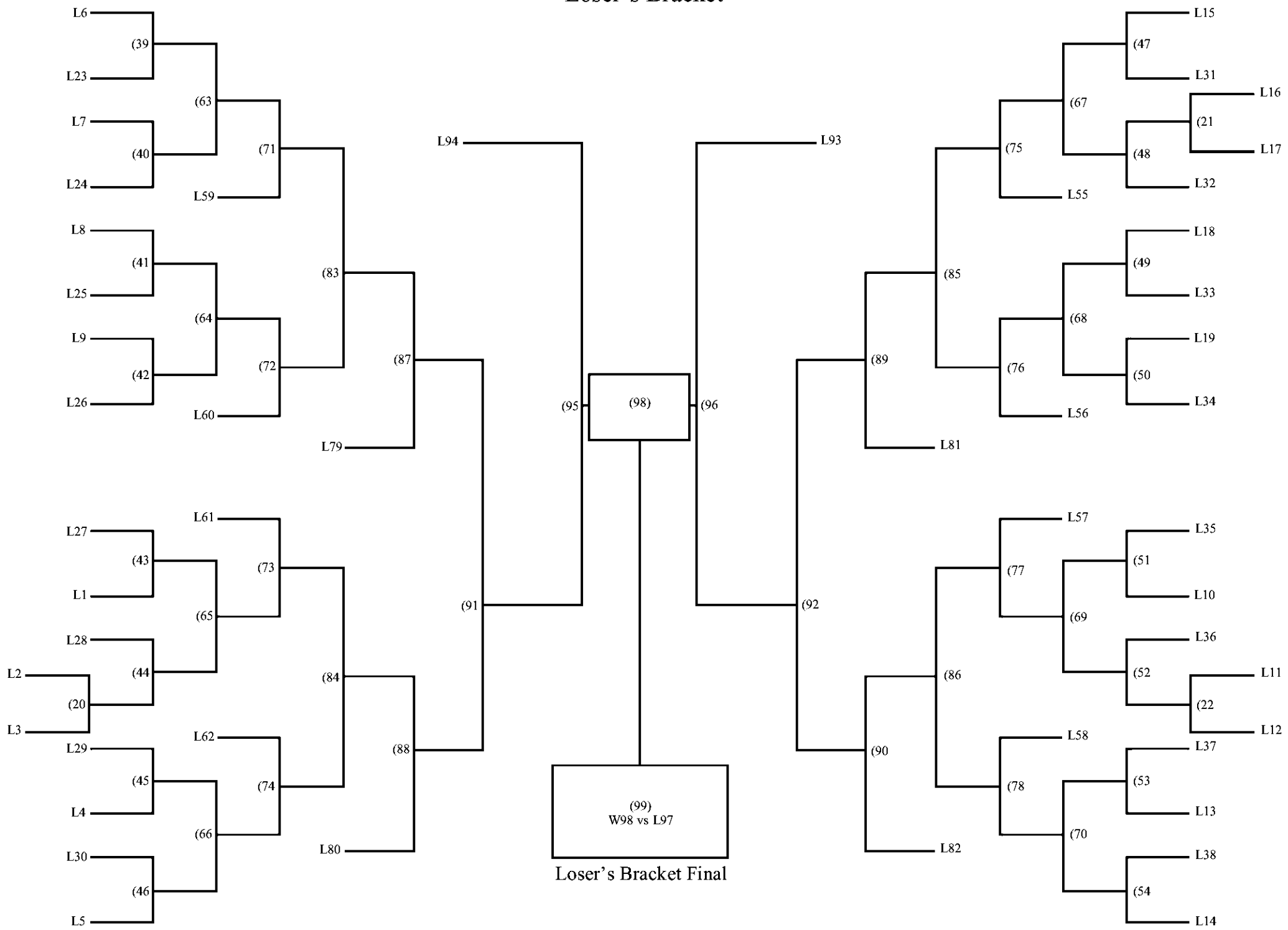

52 Person Double Elimination

Winner's Bracket

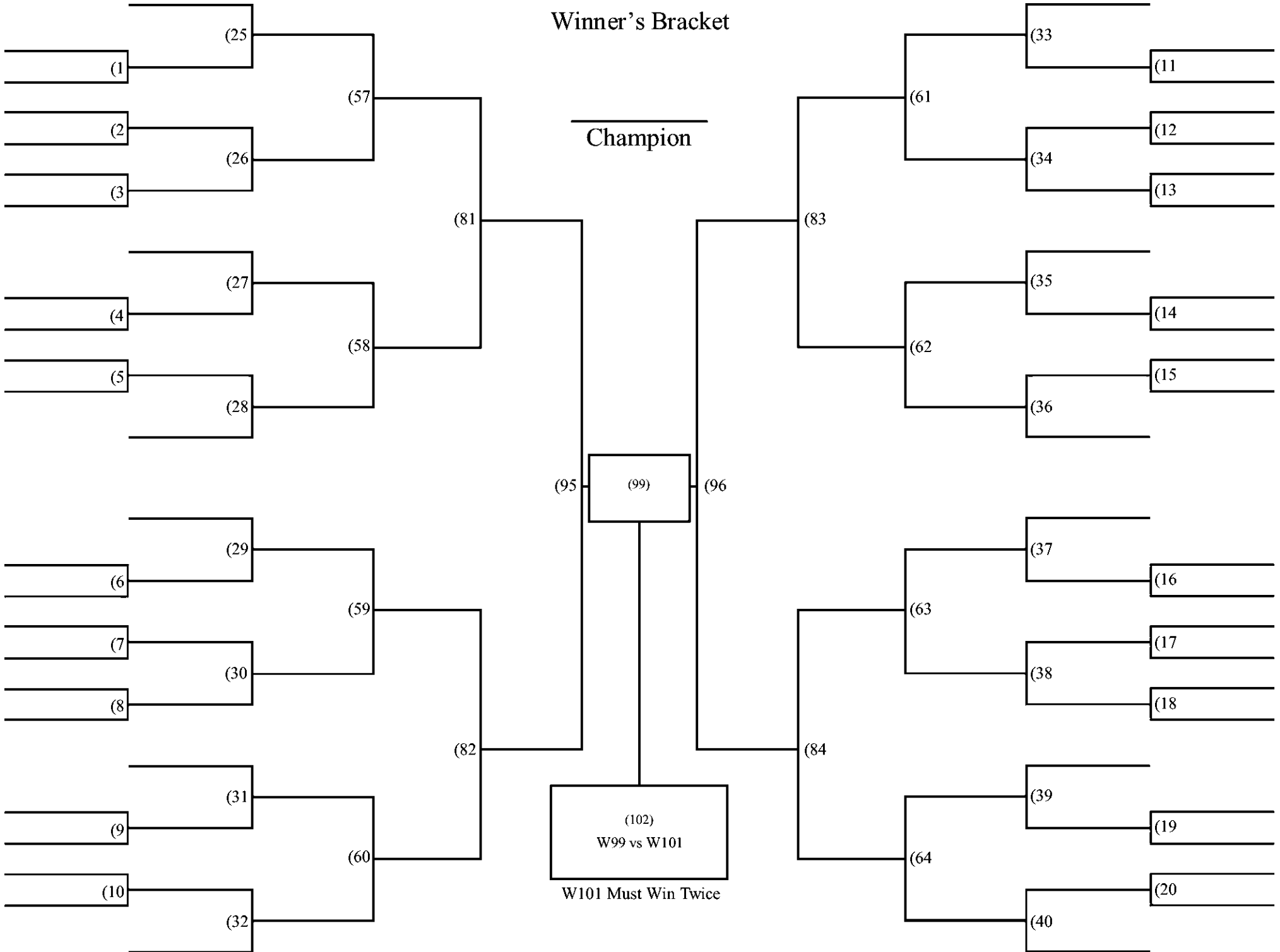

Loser's Bracket

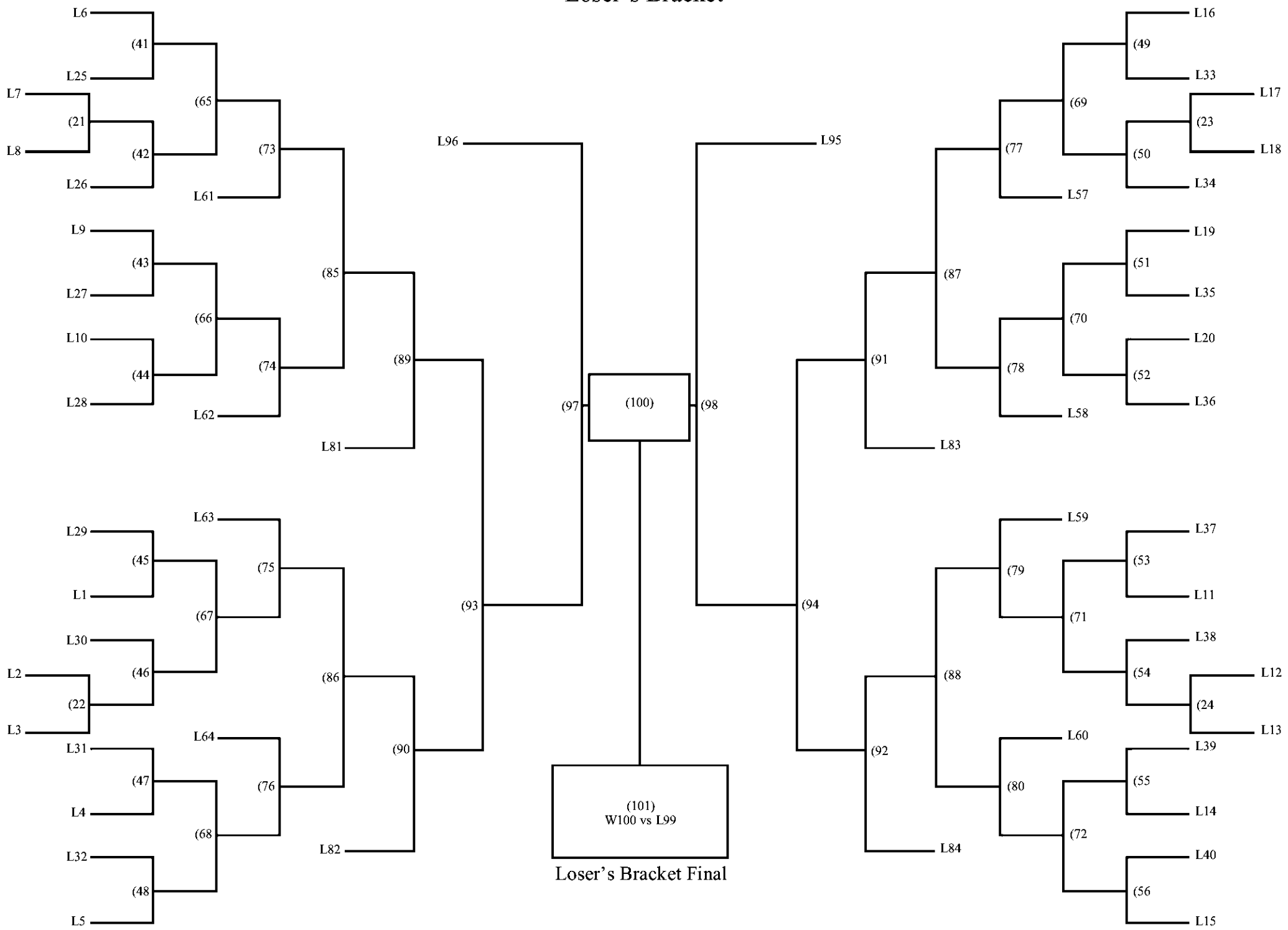

53 Person Double Elimination

Winner's Bracket

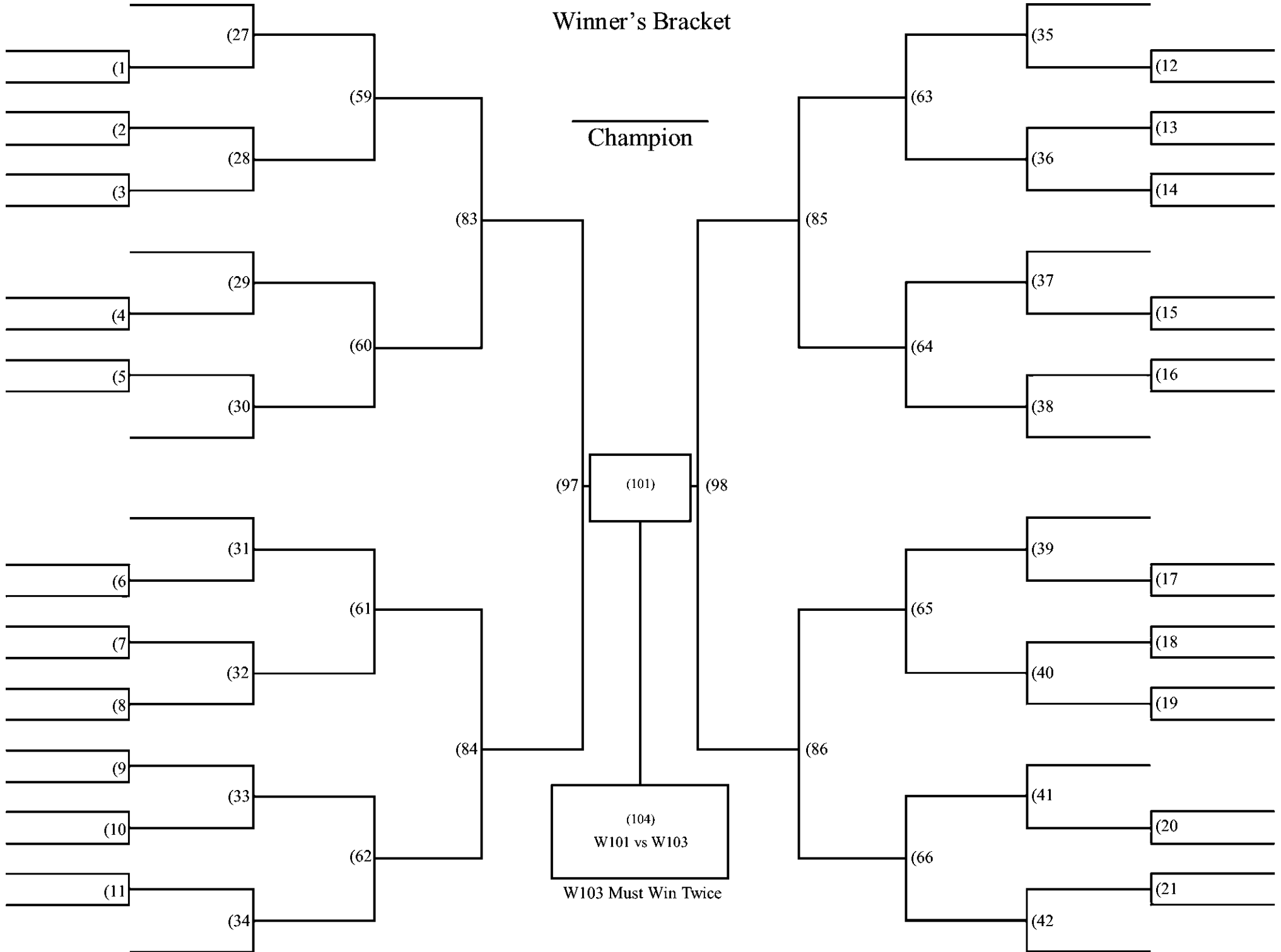

Loser's Bracket

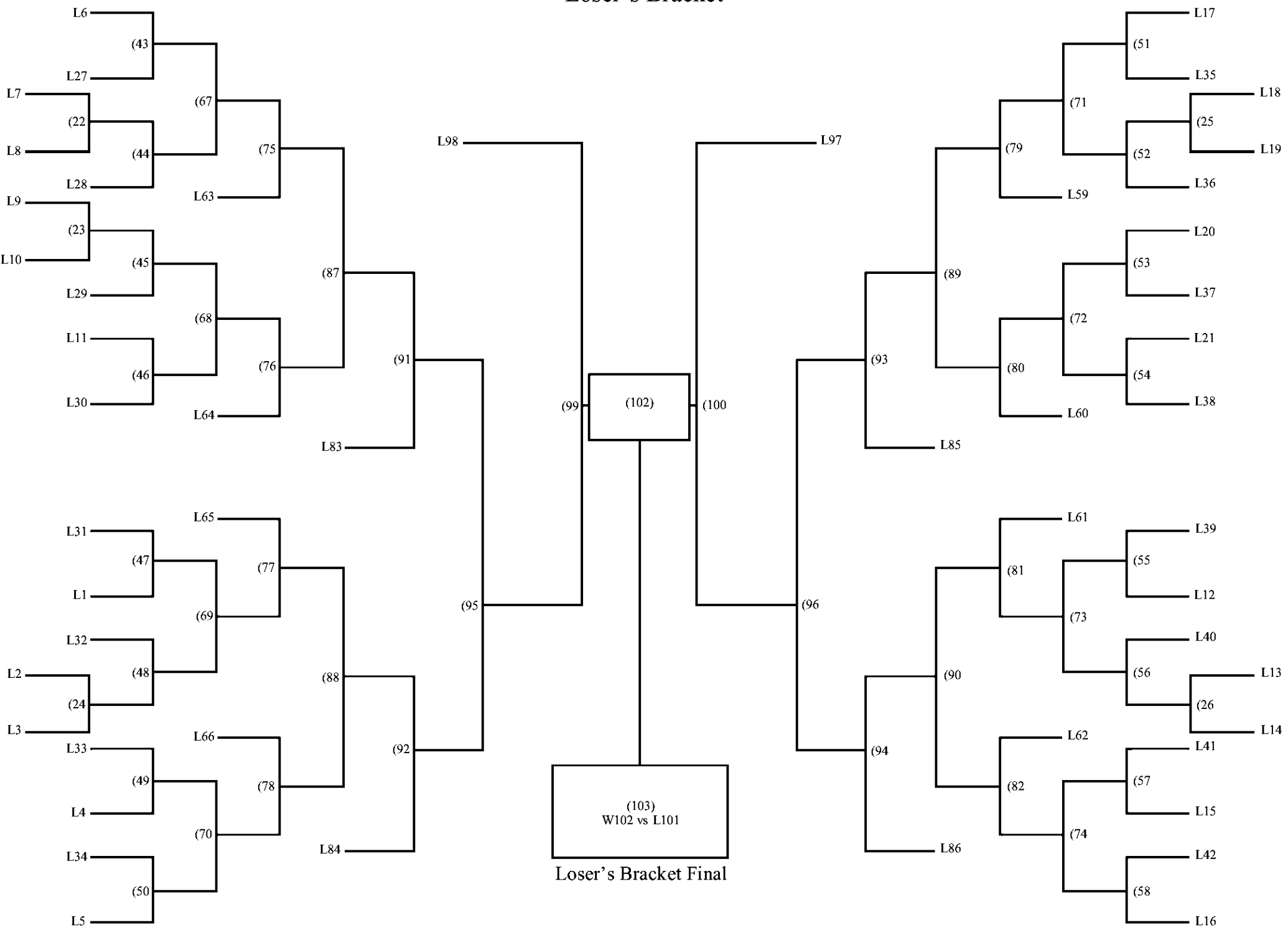

54 Person Double Elimination

Winner's Bracket



Loser's Bracket

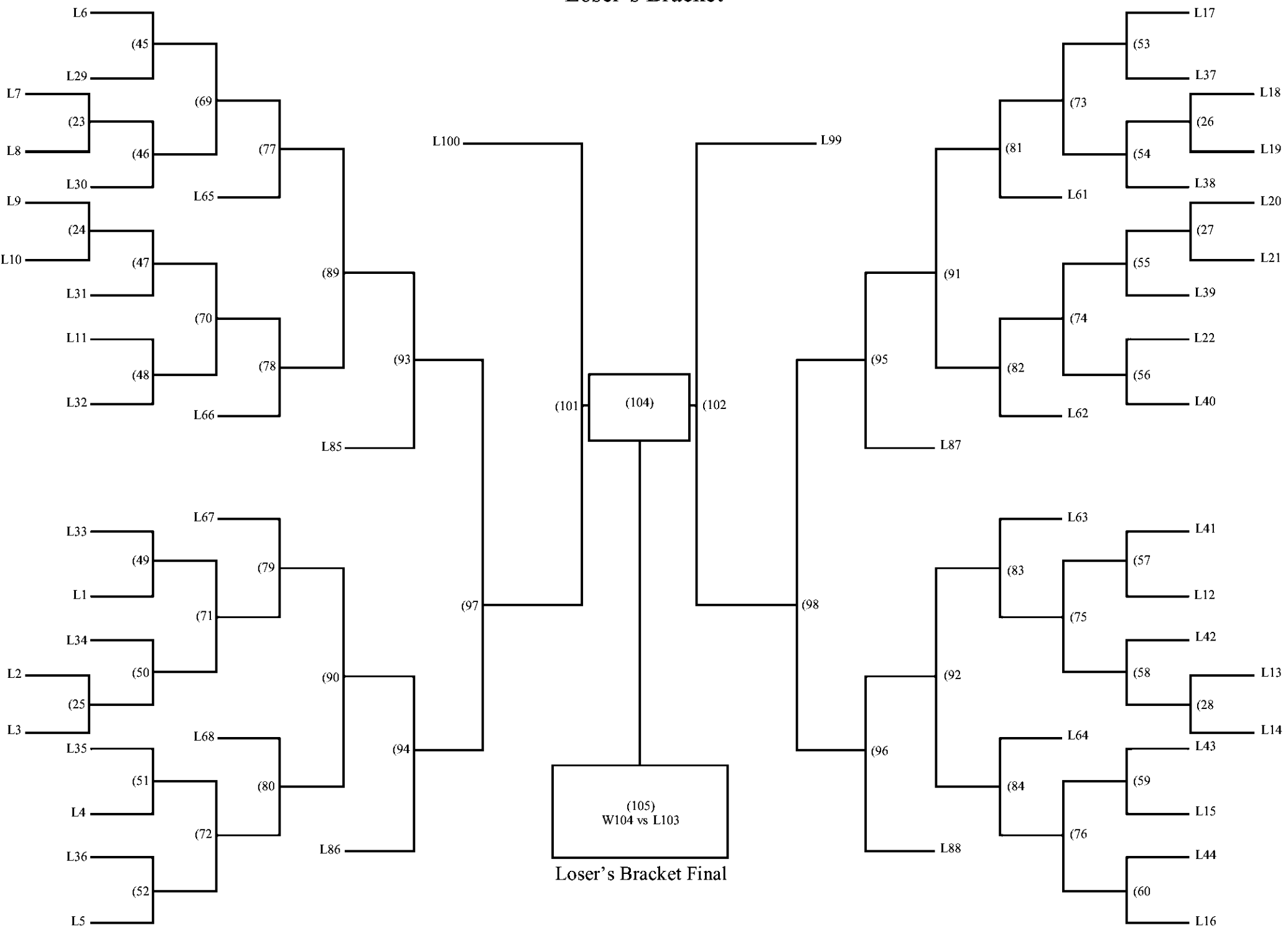

Loser's Bracket Final

55 Person Double Elimination

Winner's Bracket



Loser's Bracket

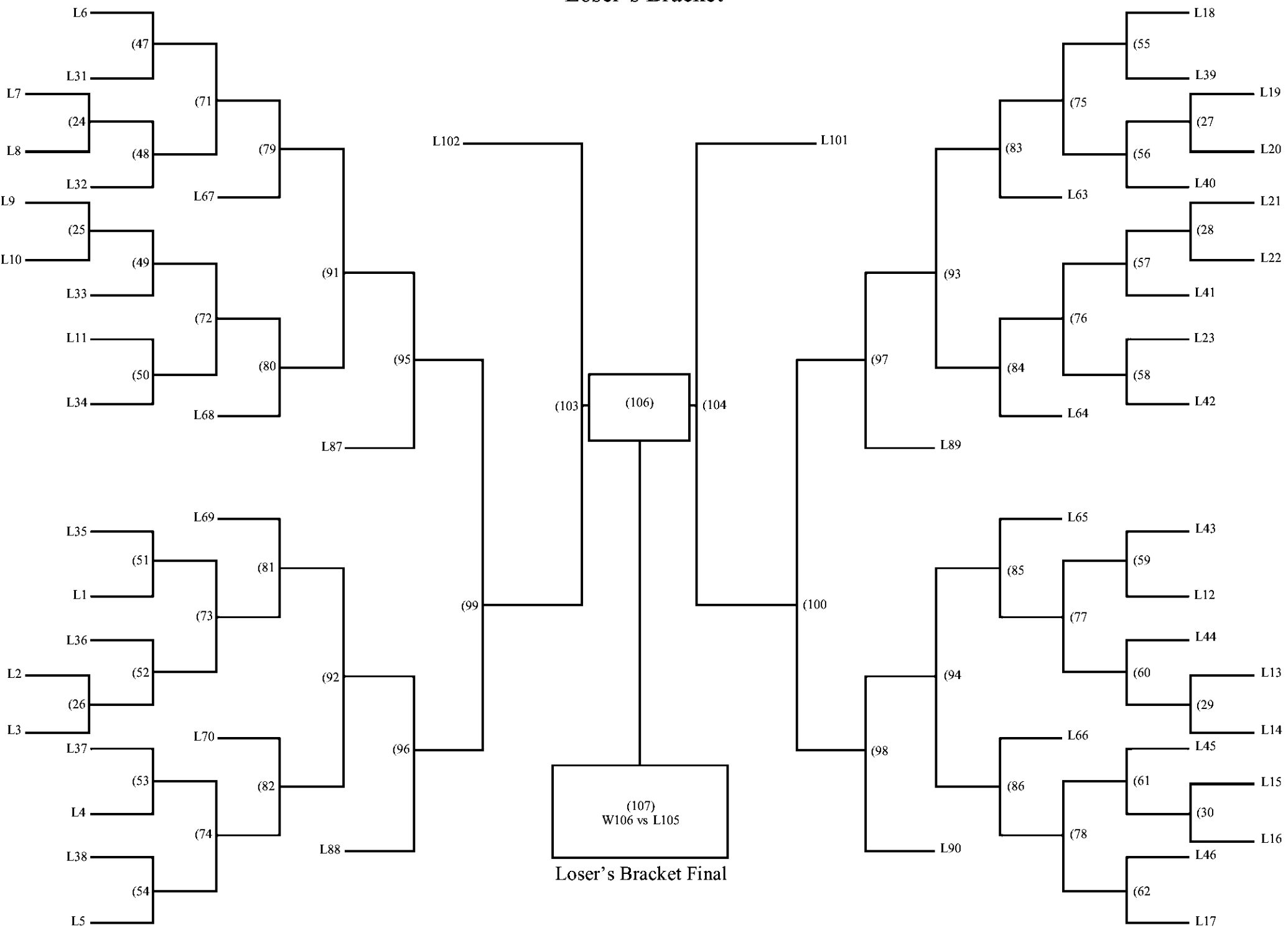

56 Person Double Elimination

Winner's Bracket

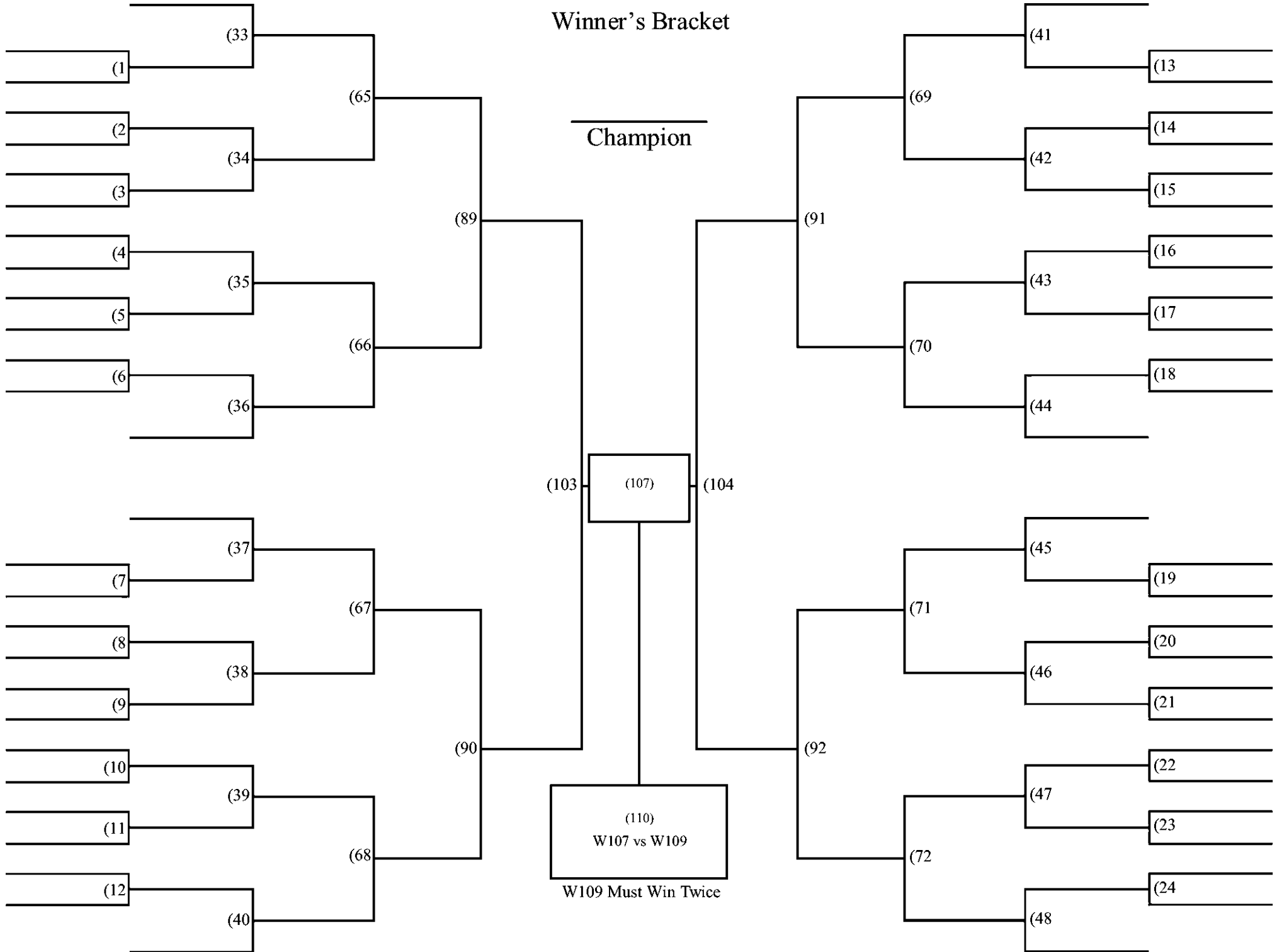

Loser's Bracket

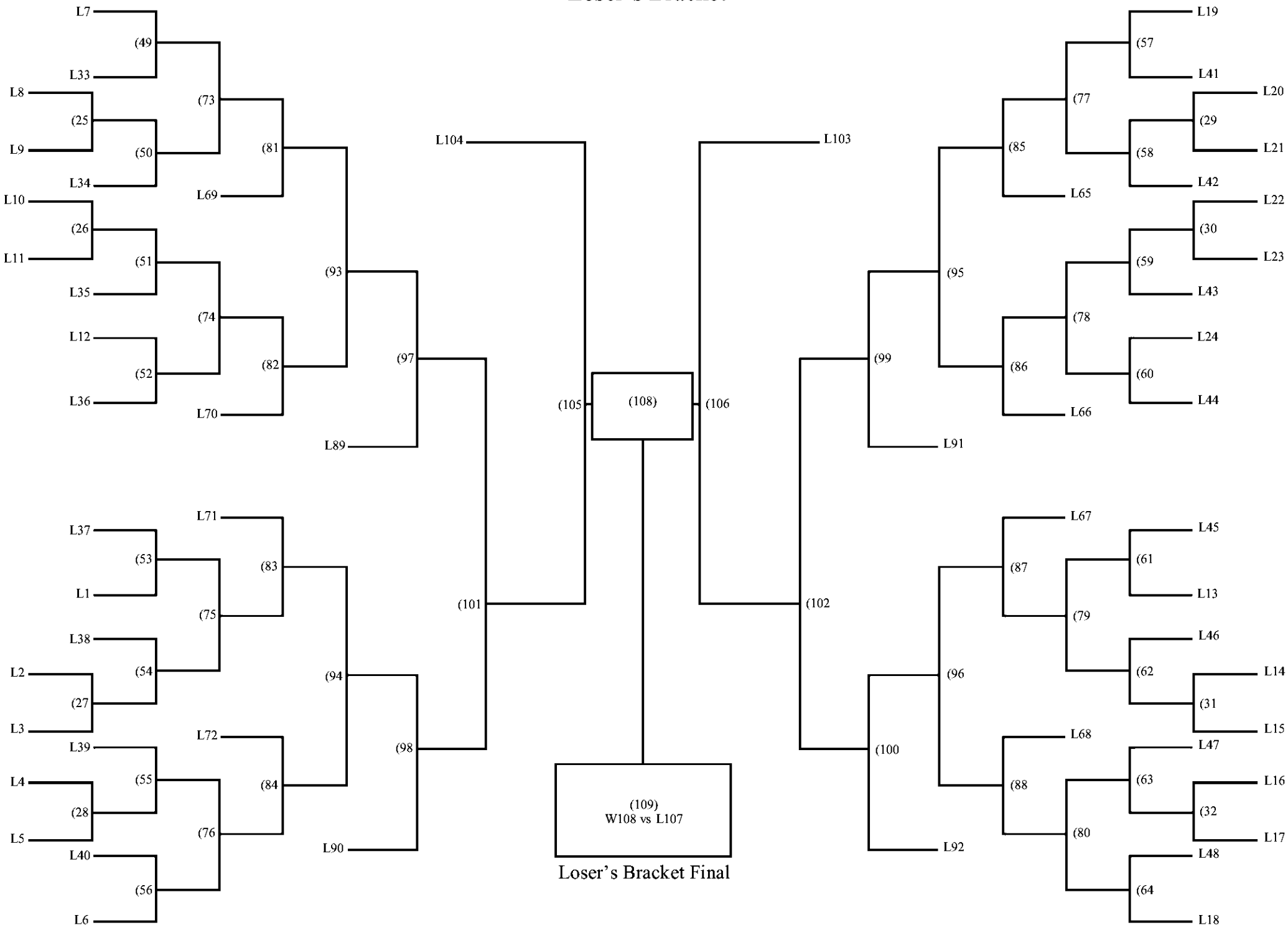

57 Person Double Elimination

Winner's Bracket

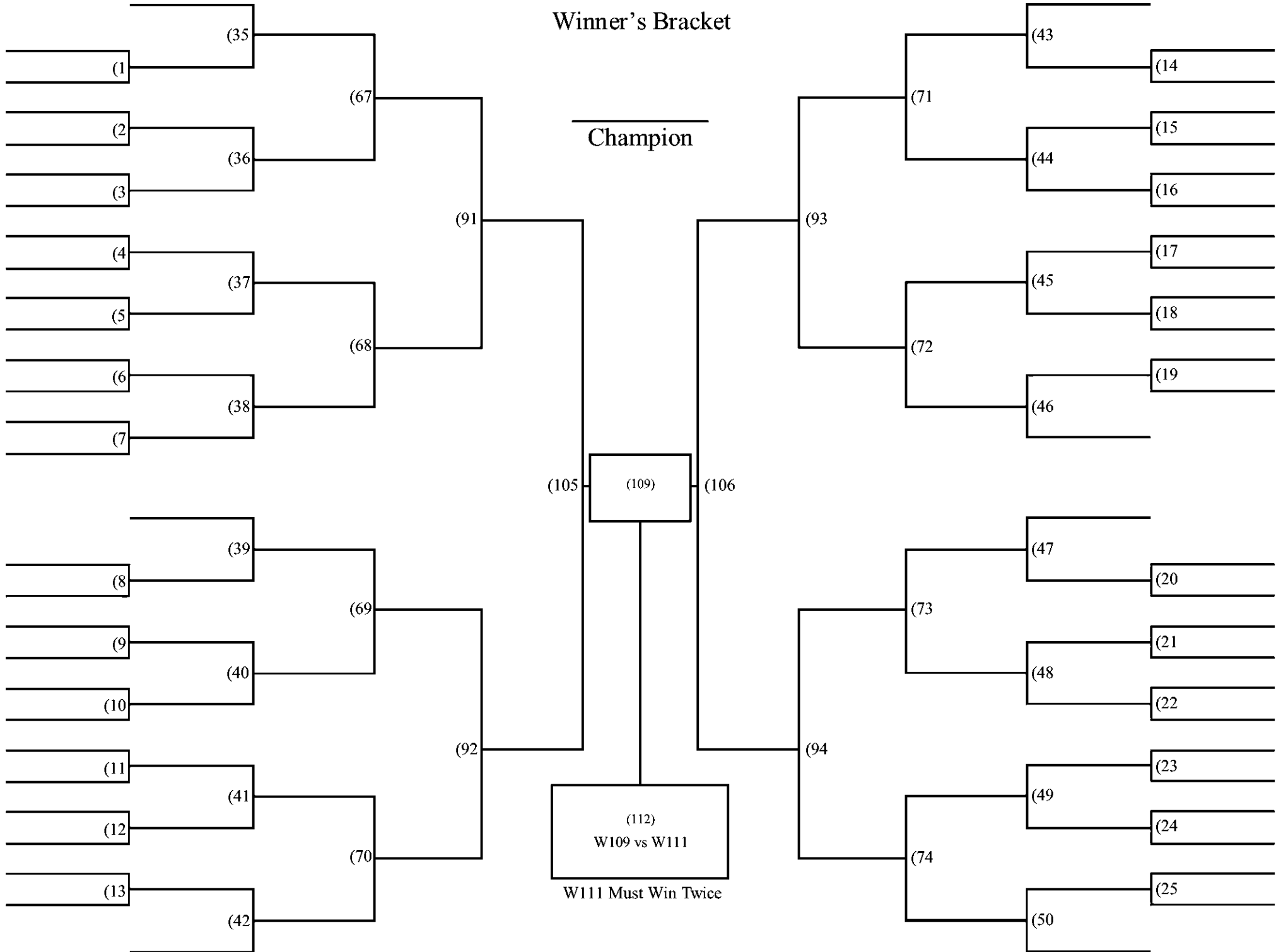

Loser's Bracket



58 Person Double Elimination

Winner's Bracket



Loser's Bracket

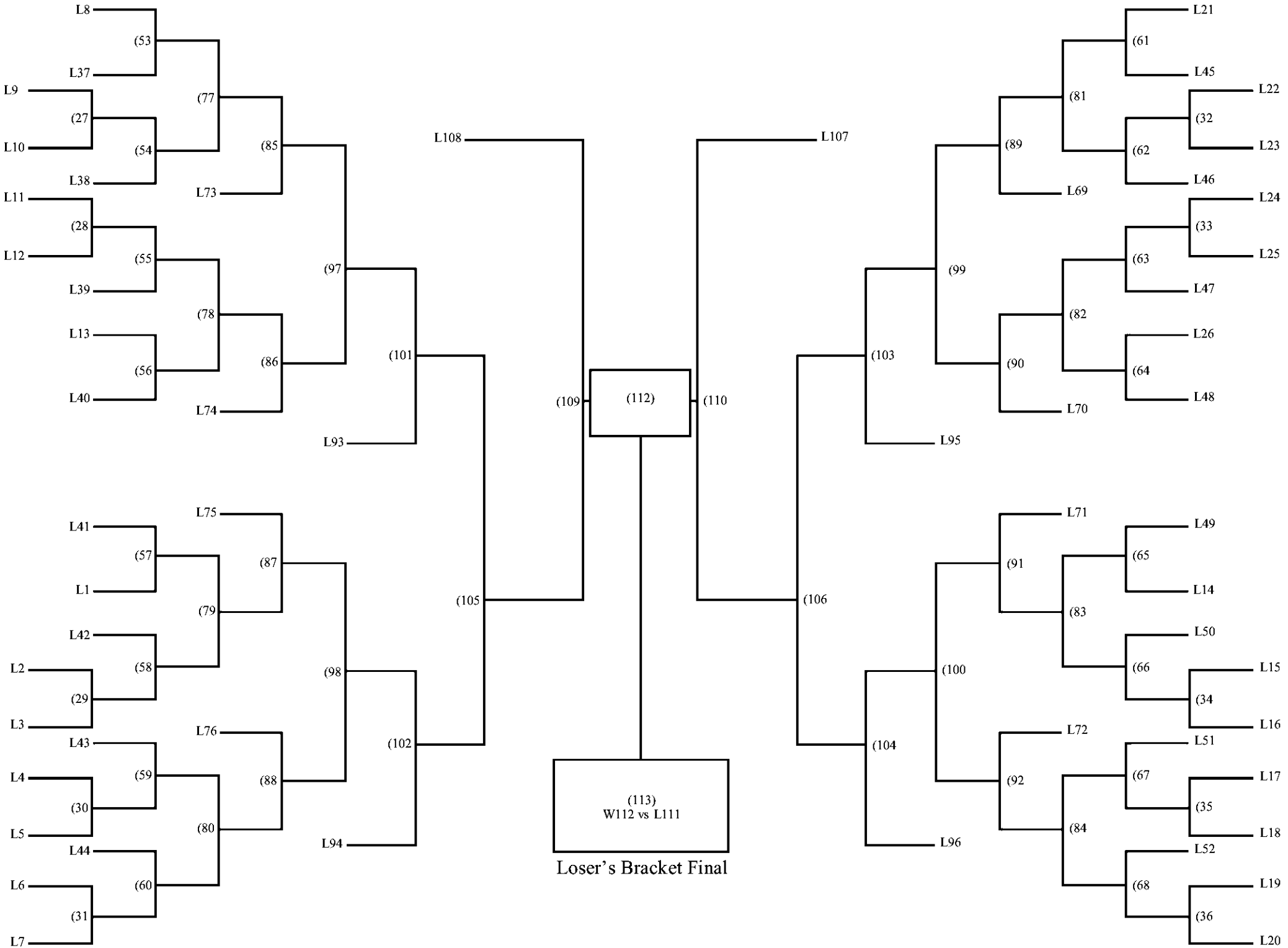

59 Person Double Elimination

Winner's Bracket

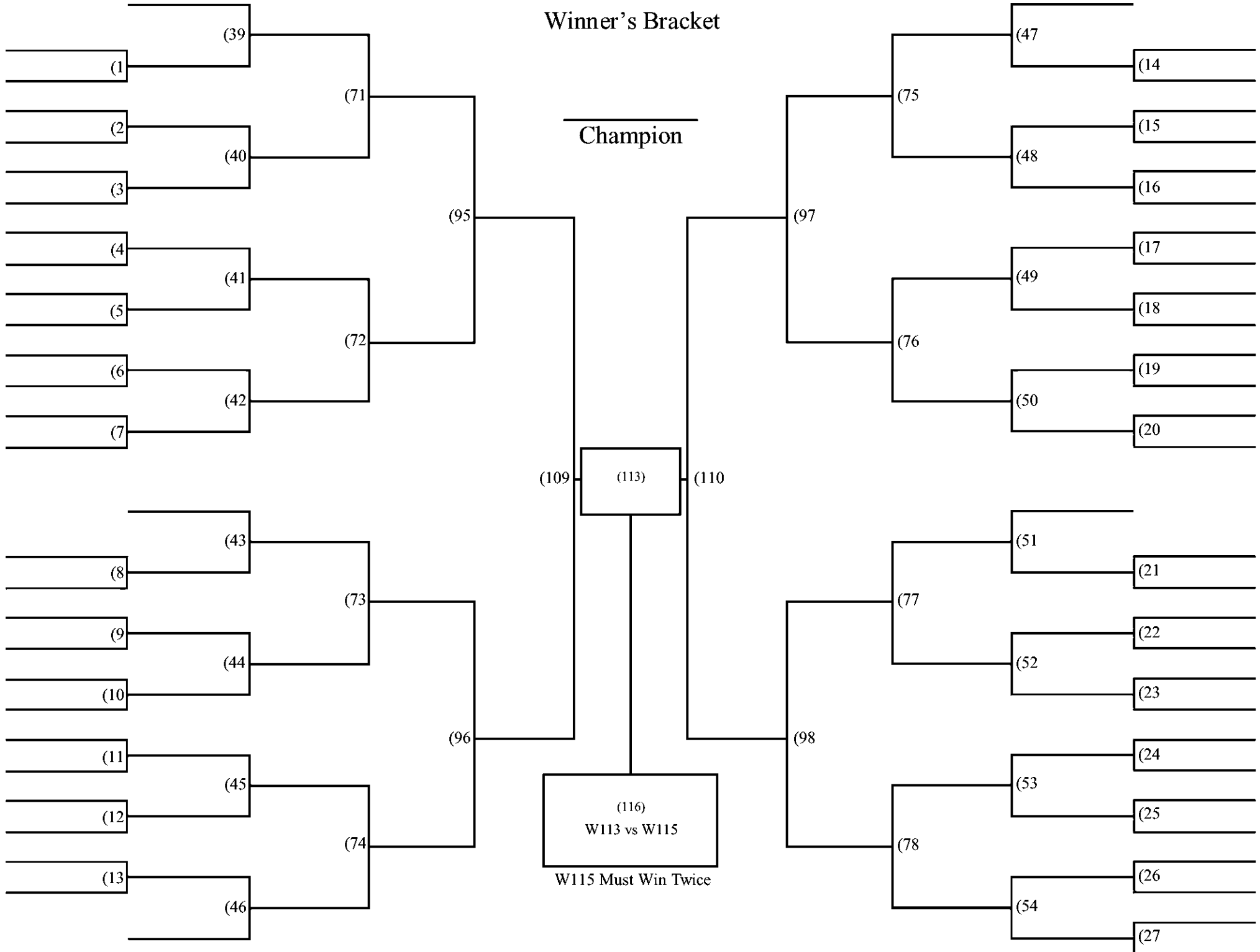

Loser's Bracket

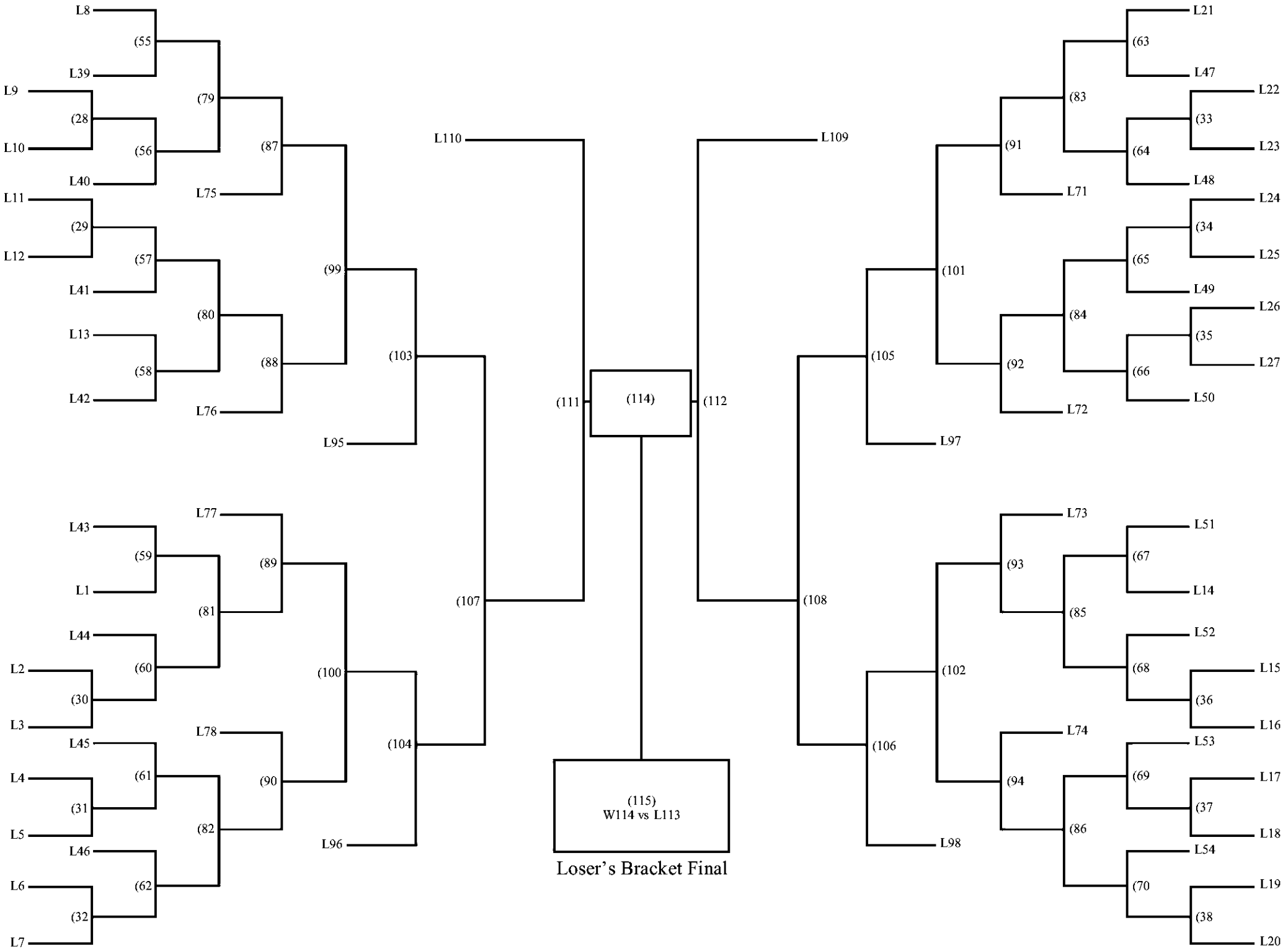

60 Person Double Elimination

Winner's Bracket

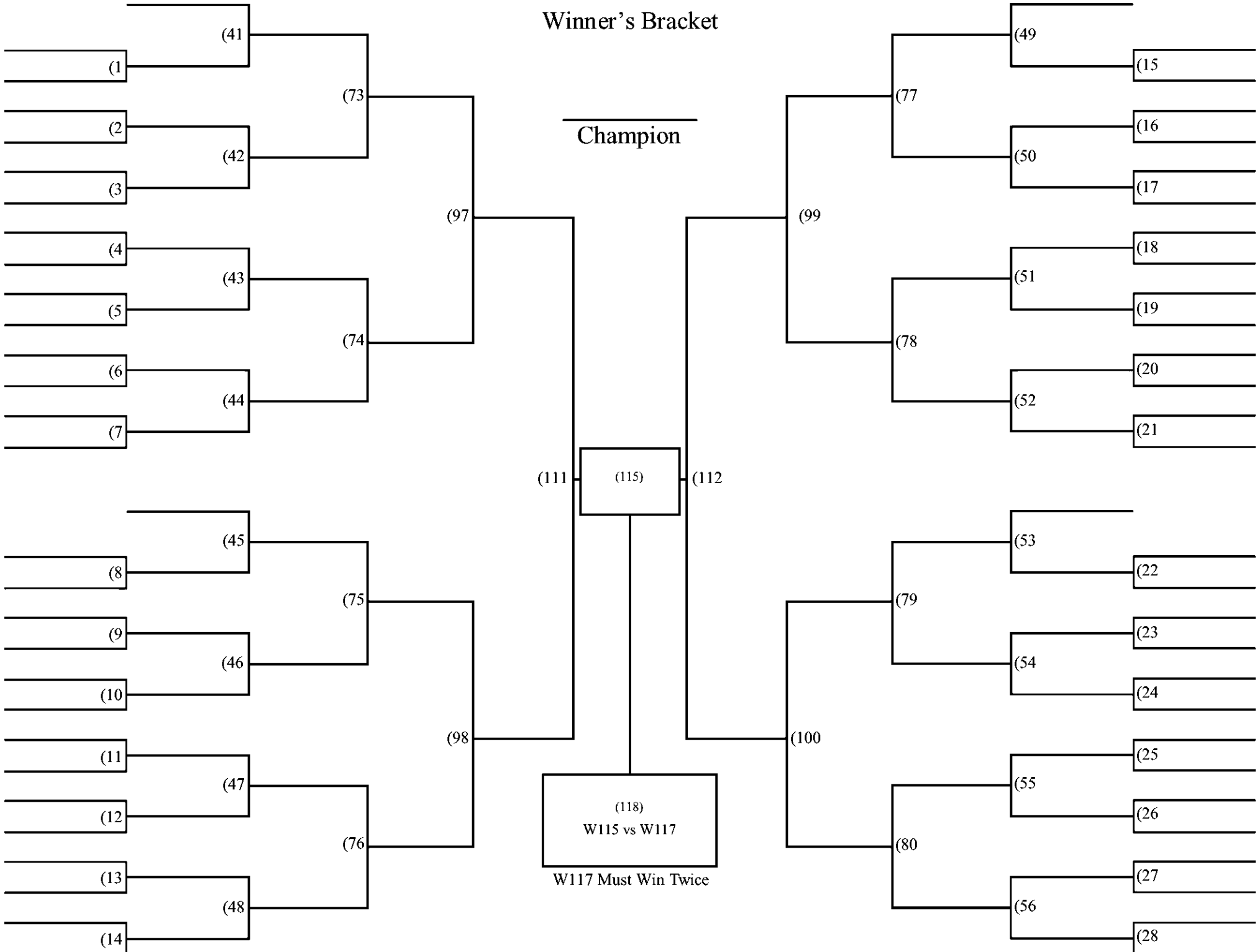

Loser's Bracket



61 Person Double Elimination

Winner's Bracket

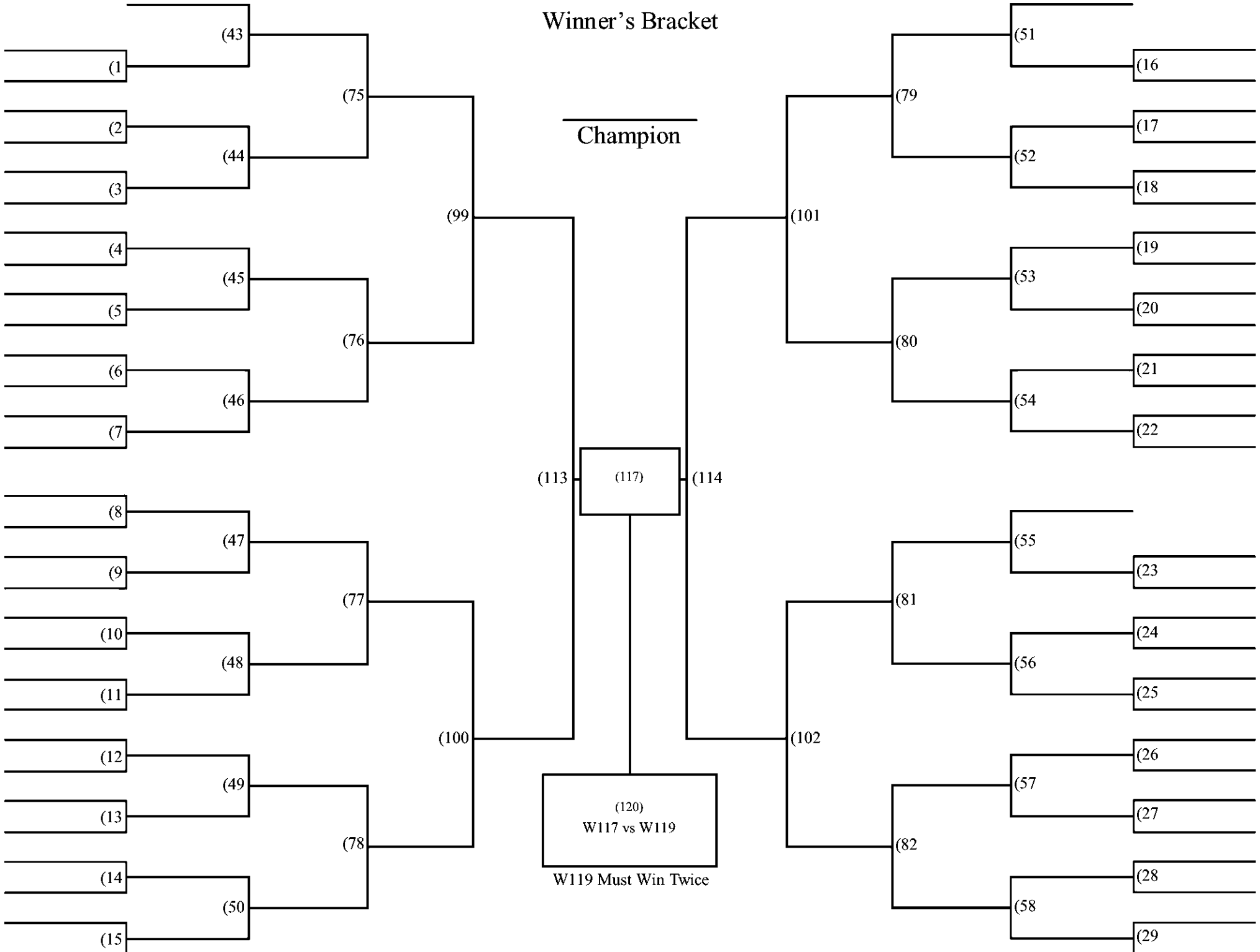

Loser's Bracket

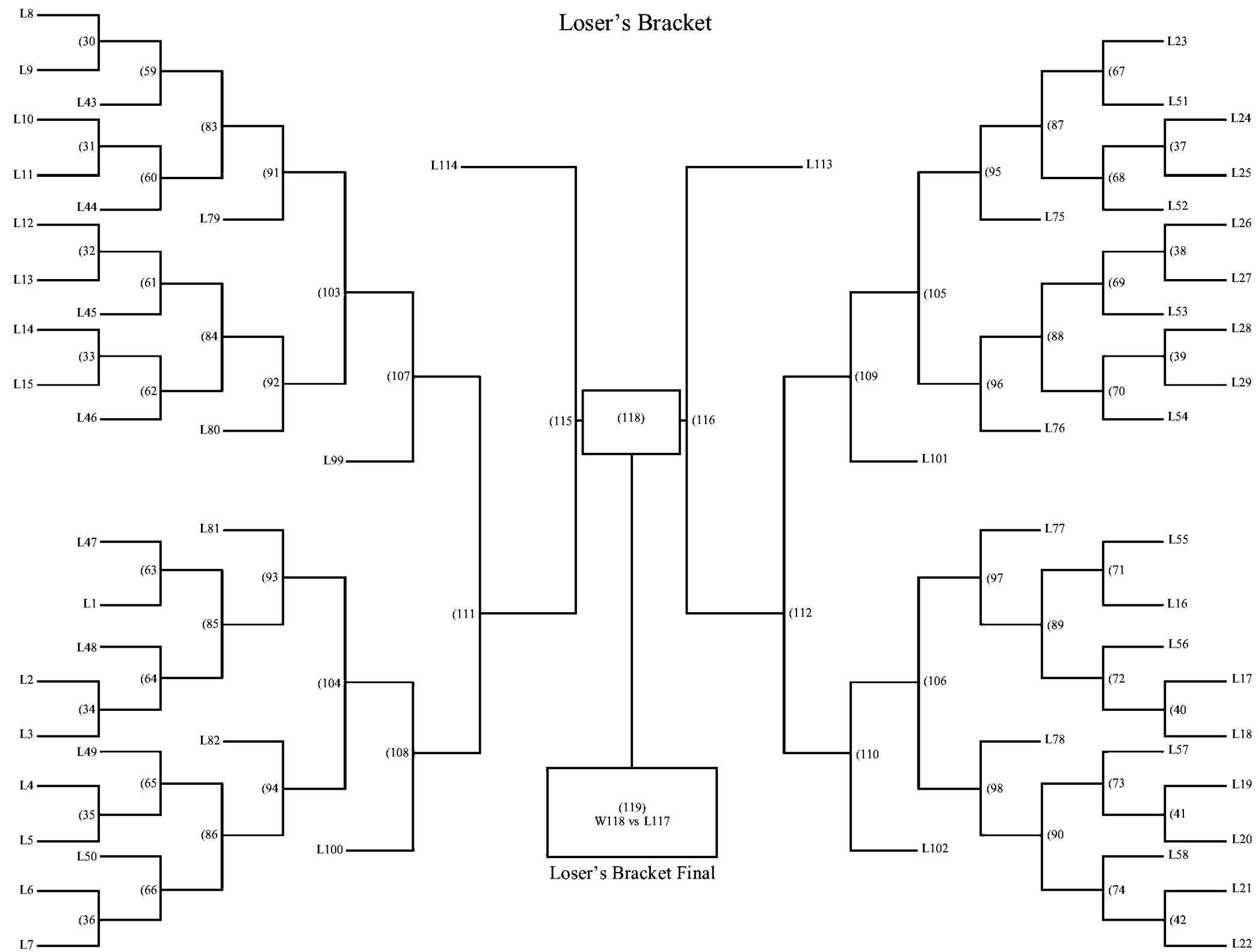

62 Person Double Elimination

Winner's Bracket

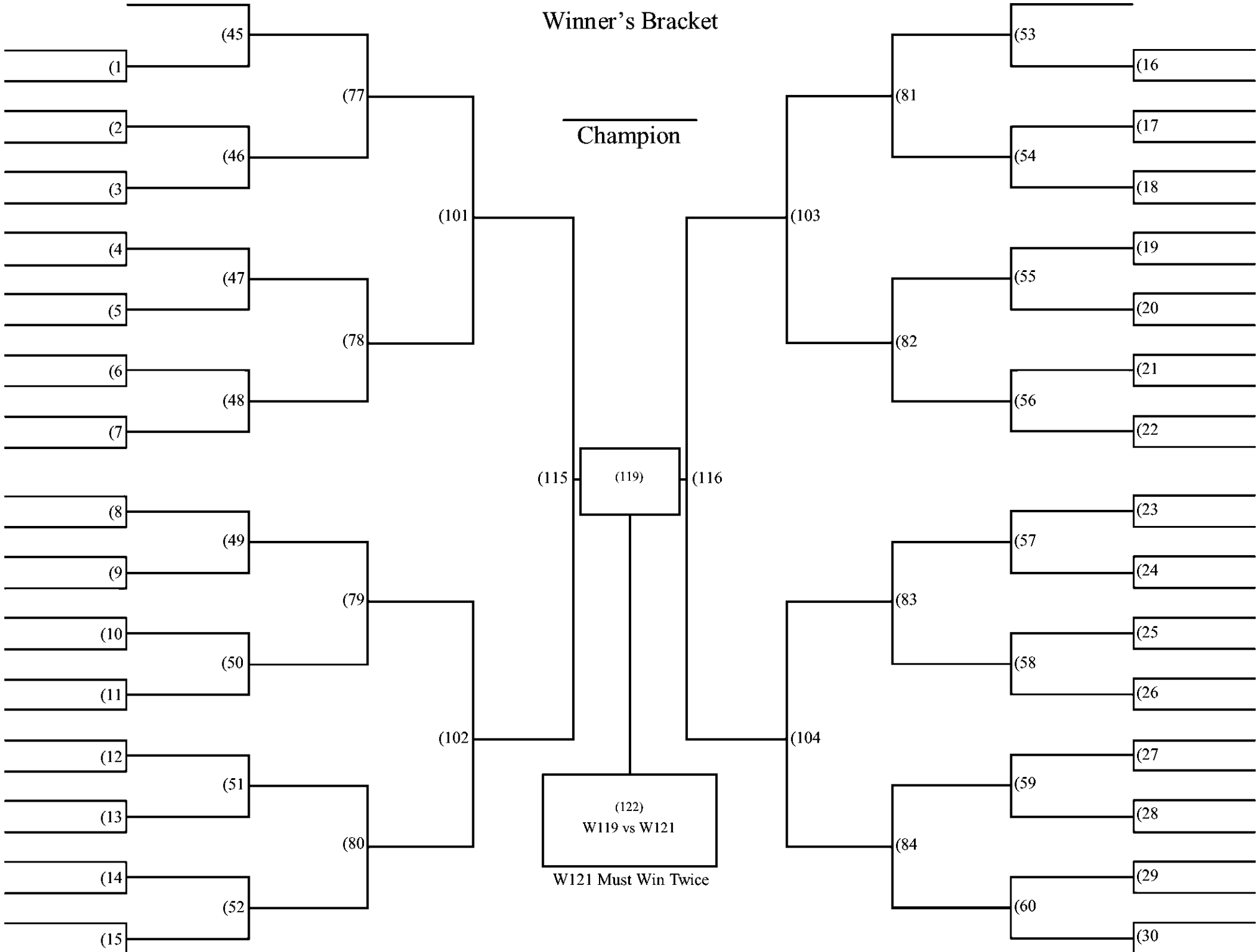

Loser's Bracket

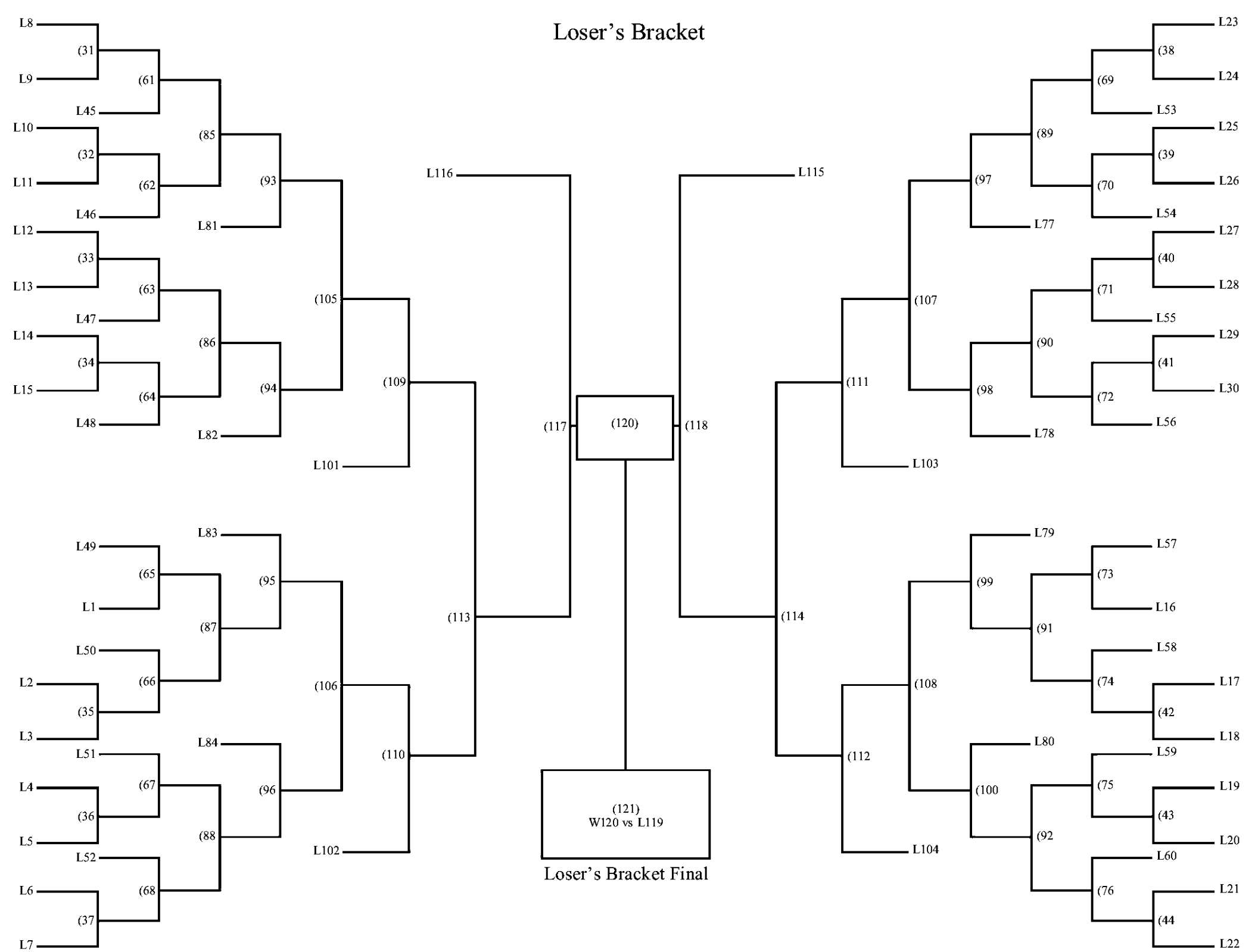

63 Person Double Elimination

Winner's Bracket



Loser's Bracket

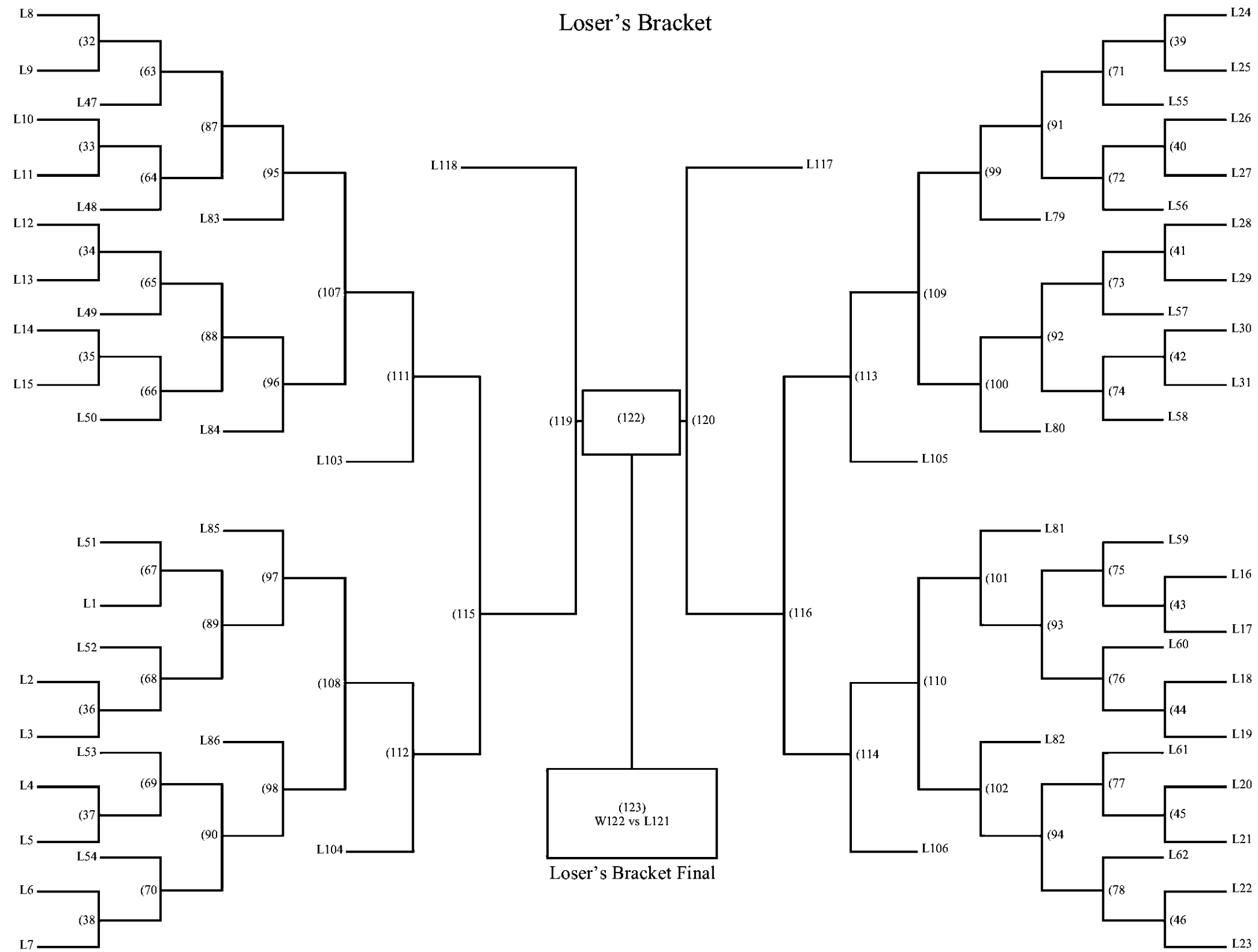

64 Person Double Elimination

Winner's Bracket



Loser's Bracket

